

PTX-DDS

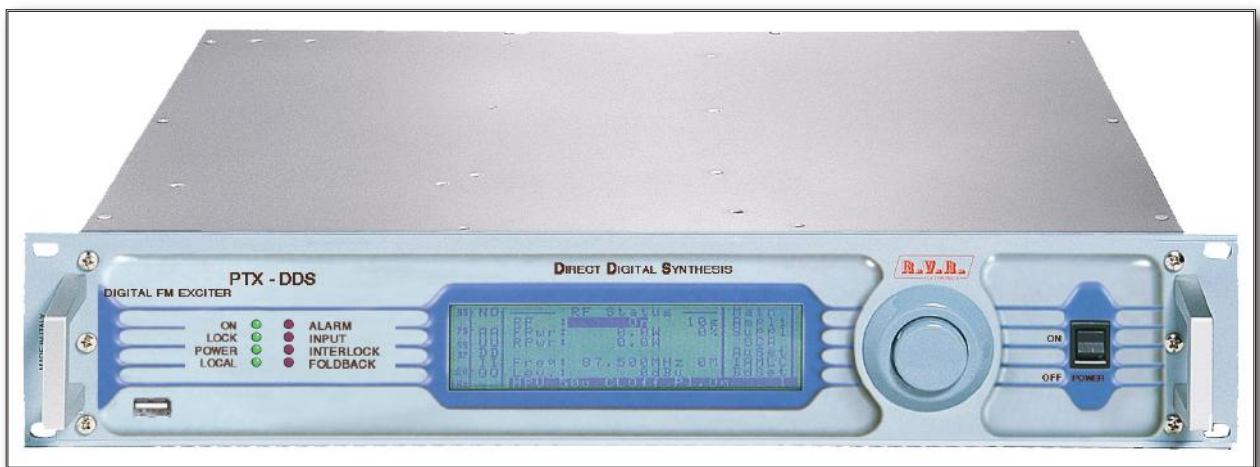

User Manual

Manufactured by



Italy



File Name: 03_PTX-DDS_ING_1.2.indd

Version: 1.2

Date: 24/01/2011

Document History

Date	Version	Reason	Editor
08/05/2006	1.0	First Edition	J. H. Berti
29/11/2010	1.1	Major Upgrade	J. H. Berti
24/11/2011	1.2	External dip-switch upgrade	J. H. Berti

PTX-DDS - User Manual
Versione 1.2

© Copyright 2006-2011
R.V.R. Elettronica SpA
Via del Fonditore 2/2c - 40138 - Bologna (Italia)
Phone: +39 051 6010506
Fax: +39 051 6011104
Email: info@rvr.it
Web: www.rvr.it

All rights reserved

Printed and bound in Italy. No part of this manual may be reproduced, memorized or transmitted in any form or by any means, electronic or mechanic, including photocopying, recording or by any information storage and retrieval system, without written permission of the copyright owner.

Notification of intended purpose and limitations of product use

This product is a FM transmitter intended for FM audio broadcasting. It utilises operating frequencies not harmonised in the intended countries of use. The user must obtain a license before using the product in intended country of use. Ensure respective country licensing requirements are complied with. Limitations of use can apply in respect of operating frequency, transmitter power and/or channel spacing.

Declaration of Conformity

Hereby, R.V.R. Elettronica SpA, declares that this FM transmitter is in compliance with the essential requirements and other relevant provisions of Directive 1999/5/EC.



Table of Contents

1.	Preliminary Instructions	1
2.	Warranty	1
3.	First Aid	2
3.1	Treatment of electrical shocks	2
3.2	Treatment of electrical Burns	2
4.	General Description	3
5.	Quick guide for installation and use	4
5.1	Preparation	4
5.2	First power-on and setup	6
6.	External Description	10
6.1	Front Panel	10
6.2	Rear Panel	11
6.3	Connector Description	12
7.	Operating System	13
7.1	Using the encoder	13
7.2	Start-up	14
7.3	Operating System	14
7.4	Menu Organization	16
7.5	Set up Reset	43
7.5	Audio Rescuer	44
7.7	I.T.U.	47
7.8	A.G.C.andClipper	47
8.	Technical Specification	49
9.	Modules Identification	51
9.1	Top View	51
9.2	Power supply unit	52
9.3	Power amplifier	52
9.4	Panel Card	52
9.5	16-bit CPU Card	53
9.6	TRDSP Card	53

This page was intentionally left blank

IMPORTANT

The symbol of lightning inside a triangle placed on the product, evidences the operations for which is necessary gave it full attention to avoid risk of electric shocks.



The symbol of exclamation mark inside a triangle placed on the product, informs the user about the presence of instructions inside the manual that accompanies the equipment, important for the efficacy and the maintenance (repairs).

1. Preliminary Instructions

• General foreword

The equipment in object is to considering for uses, installation and maintenance from "trained" or "qualified" staff, they conscious of the risks connected to operate on electronic and electrical circuits electrical.

The "trained" definition means staff with technical knowledge about the use of the equipment and with responsibility regarding the own safety and the other not qualified staff safety place under his directed surveillance in case of works on the equipment.

The "qualified" definition means staff with instruction and experience about the use of the equipment and with responsibility regarding the own safety and the other not qualified staff safety place under his directed surveillance in case of works on the equipment.

 **WARNING:** The machine can be equipped with an ON/OFF switch which could not remove completely voltages inside the machine. It is necessary to have disconnected the feeding cord, or to have switched off the control panel, before to execute technical operations, making sure himself that the safety connection to ground is connected.

The technical interventions that expect the equipment inspection with circuits under voltage must be carry out from trained and qualified staff in presence of a second trained person that it is ready to intervene removing voltage in case of need.

R.V.R. Elettronica SpA doesn't assume responsibility for injury or damage resulting from improper procedures or practices by untrained/unqualified personnel in the handling of this unit.

 **WARNING:** The equipment is not water resistant and an infiltration could seriously compromise its correct operation. In order to prevent fires or electric shocks, do not expose the equipment to rain, infiltrations or humidity.

Please observe all local codes and fire protection standards during installation and use of this unit.

 **WARNING:** The equipment has to its inside exposed parts to risk of electric shock, always disconnect power before opening covers or removing any part of this unit.

Fissures and holes are supplied for the ventilation in order to assure a reliable efficacy of the product that for protect itself from excessive heating, these fissures do not have to be obstructed or to be covered. The fissures doesn't be obstructed in no case. The product must not be incorporated in a rack, unless it is supplied with a suitable ventilation or that the manufacturer's instructions are been followed.

 **WIRING:** This equipment can irradiate radio frequency energy and if it's not installed following the instructions contained in the manual and local regulations it could generate interferences in radio communications.

 **WIRING:** This device has a connection to ground on the power cord and on the chassis. Check that they are correctly connected.

Operate with this device in a residential ambient can cause radio disturbs; in this case, it can be demanded to the user to take adequate measures.

Specifications and informations contained in this manual are furnished for information only, and are subject to change at any time without notice, and should not be construed as a commitment by R.V.R. Elettronica SpA.

The R.V.R. Elettronica SpA assumes no responsibility or liability for any errors or inaccuracies that may appear in this manual, including the products and software described in it; and it reserves the right to modify the design and/or the technical specifications of the product and this manual without notice.

• **Warning regarding the use designated and the use limitations of the product.**

This product is an transmitter radio indicated for the audio broadcasting service in frequency modulation. It uses working frequencies that are not harmonized in the states of designated user.

The user of this product must obtain from the Authority for spectrum management in the state of designated user the appropriate authorization to use the radio spectrum, before putting in exercise this equipment.

The working frequency, the transmitter power, let alone other specifications of the transmission system are subject to limitation and defined in the authorization obtained.

2. Warranty

R.V.R. Electronics S.P.A. guarantees absence of manufacturing defect and the good operation for the products, within the provided terms and conditions.

Please read the terms carefully, because the purchase of the product or acceptance of order confirmation, constitutes acceptance of the terms and conditions.

For the last legal terms and conditions, please visit our web site (WWW.RVR.IT) wich may also be changed, removed or updated for any reason without prior notice.

Warranty will be void in cases of opened products, physical damage, misuse, modification, repair by unauthorised persons, carelessness and using the product for other purpose than its intended use.

In case of defect, proceed like described in the following:

- 1 Contact the dealer or distributor where you purchased the unit. Describe the problem and, so that a possible easy solution can be detected.

Dealers and Distributors are supplied with all the information about problems that may occur and usually they can repair the unit quicker than what the manufacturer could do. Very often installing errors are discovered by dealers.

- 2 If your dealer cannot help you, contact R.V.R. Elettronica and explain the problem. If it is decided to return the unit to the factory, R.V.R. Elettronica will mail you a regular authorization with all the necessary instructions to send back the goods;

- 3 When you receive the authorization, you can return the unit. Pack it carefully for the shipment, preferably using the original packing and seal the package perfectly. The customer always assumes the risks of loss (i.e.,

R.V.R. is never responsible for damage or loss, until the package reaches R.V.R. premises. For this reason, we suggest you to insure the goods for the whole value. Shipment must be effected C.I.F. (PREPAID) to the address specified by R.V.R.'s service manager on the authorization



DO NOT RETURN UNITS WITHOUT OUR AUTHORIZATION AS THEY WILL BE REFUSED

- 4 Be sure to enclose a written technical report where mention all the problems found and a copy of your original invoice establishing the starting date of the warranty.

Replacement and warranty parts may be ordered from the following address. Be sure to include the equipment model and serial number as well as part description and part number.



R.V.R. Elettronica SpA
Via del Fonditore, 2/2c
40138 BOLOGNA ITALY
Tel. +39 051 6010506

3. First Aid

The personnel employed in the installation, use and maintenance of the device, shall be familiar with theory and practice of first aid.

3.1 Treatment of electrical shocks

3.1.1 If the victim is not responsive

Follow the A-B-C's of basic life support.

- Place victim flat on his back on a hard surface.
- Open airway: lift up neck, push forehead back (Figure 1).

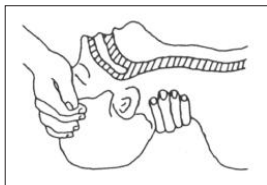

Figure 1

- clear out mouth if necessary and observe for breathing
- if not breathing, begin artificial breathing (Figure 2): tilt head, pinch nostrils, make airtight seal, four quick full breaths. Remember mouth to mouth resuscitation must be commenced as soon as possible.



Figure 2

- Check carotid pulse (Figure 3); if pulse is absent, begin artificial circulation (Figure 4) depressing sternum (Figure 5).

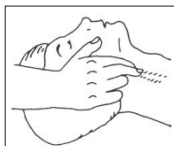

Figure 3



Figure 4

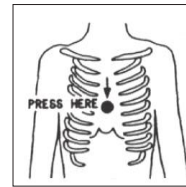

Figure 5

- In case of only one rescuer, 15 compressions alternated to two breaths.
- If there are two rescuers, the rhythm shall be of one breath each 5 compressions.
- Do not interrupt the rhythm of compressions when the second person is giving breath.
- Call for medical assistance as soon as possible.

3.1.2 If victim is responsive

- Keep them warm.
- Keep them as quiet as possible.
- Loosen their clothing (a reclining position is recommended).
- Call for medical help as soon as possible.

3.2 Treatment of electrical Burns

3.2.1 Extensive burned and broken skin

- Cover area with clean sheet or cloth.
- Do not break blisters, remove tissue, remove adhered particles of clothing, or apply any salve or ointment.
- Treat victim for shock as required.
- Arrange transportation to a hospital as quickly as possible.
- If arms or legs are affected keep them elevated.

If medical help will not be available within an hour and the victim is conscious and not vomiting, give him a weak solution of salt and soda: 1 level teaspoonful of salt and 1/2 level teaspoonful of baking soda to each quart of water (neither hot or cold).

Allow victim to sip slowly about 4 ounces (half a glass) over a period of 15 minutes.

Discontinue fluid if vomiting occurs.

DO NOT give alcohol.

3.2.2 Less severe burns

- Apply cool (not ice cold) compresses using the cleansed available cloth article.
- Do not break blisters, remove tissue, remove adhered particles of clothing, or apply salve or ointment.
- Apply clean dry dressing if necessary.
- Treat victim for shock as required.
- Arrange transportation to a hospital as quickly as possible.
- If arms or legs are affected keep them elevated.

4. General Description

The **PTX-DDS** is a FM digital exciter, DDS (Direct Digital Synthesizer), featuring a 19" RACK-mountable form factor.

User interface consists of a graphic liquid crystal display and a knob (encoder). This interface lets you view all parameters relating to machine operation and adjust settable parameters (e.g.: power level or working frequency).

The exciter has been designed to easily integrate into complex transmission systems. To this end, it is capable of accepting data from, controlling or interacting with external equipments, such as amplifiers, switching units, relays or other exciters.

The **PTX-DDS** design is based on a modular concept: the different functions are performed by modules that are connected directly through male and female connectors or through flat cables terminated by connectors. This design facilitates maintenance and module replacement.

A LCD on the front panel and a control knob provide for user interfacing with the microprocessor control system, which implements the following feature:

- Set up of the power output
- Set up of the working frequency
- Enabling or disabling of the power output delivery
- Measurement and visualization of the working parameters
- Communication with external devices

The management software offers an intuitive user interface and runs on any PC in the WINDOWS™ environment.

On the rear panel is placed the audio section, which allows the interfacing with other devices. From this section are available the analogic connectors for audio input (mono, audio stereo, MPX), digital audio input (AES/EBU electrical and optical), 19kHz pilot tone output and two SCA input for signals modulated on subcarriers from external coders, it is normally used in Europe for RDS transmission (Radio Data System).

The audio section includes functionality of RDS coder, externally programmable through the proper RVR software.

There are also placed the mains power plug, RF output, RF test, the remote connector and the protection fuse.

The equipment foresees several options on request, as GPS board function.

5. Quick guide for installation and use

This section provides a step-by-step description of the machine installation and configuration procedure. Follow these procedures closely upon first power-on and each time any change is made to general configuration, such as when a new transmission station is added or the amplifier is replaced.

Once the desired configuration has been set up, no more settings are required for normal operation; at each power-up (even after an accidental shutdown), the amplifier defaults to the parameters set during the initial configuration procedure.

The topics covered in this section are discussed at greater length in the next sections, with detailed descriptions of all hardware and firmware features and capabilities. Please see the relevant sections for additional details.



IMPORTANT: *When configuring and testing the transmitter in which the exciter is integrated, be sure to have the Final Test Table supplied with the machine ready at hand throughout the whole procedure; the Final Test Table lists all operating parameters as set and tested at the factory.*

5.1 Preparation

5.1.1 Preliminary checks

Unpack the amplifier and immediately inspect it for transport damage. Ensure that all connectors are in perfect condition.

Provide for the following (applicable to operating tests and putting into service):

- √ Single-phase 230 VAC (-15% / +10%), or 115 VAC through internal connector, mains power supply with adequate ground connection
- √ For operating tests only: dummy load with 50 Ohm impedance and adequate capacity
- √ Connection cable kit including:
 - Mains power cable

5.1.2 Mains power supply



WARNING: *Disconnect mains power supply before beginning these procedures.*

The mains power supply protection fuse is conveniently located on the rear panel and are easily accessed (see figure 6.2): to check or replace a fuse, **disconnect machine from power mains**, unscrew fuse cover and pull fuse out of socket.

The following fuse is used:

	@ 115 Vac/230 Vac
Main Power Supply (fig. 6.2 - item [15])	(1x) 6.3AT type 5x20

Table 5.1: Fuse

5.1.3 Connections

Connect a suitable dummy load with suitable dissipation power, or antenna, or the input of final amplifier (for instance, PJ1000-LIGHT exciter available from R.V.R. Elettronica) to the RF output (see figure 6.2 - item [3]) using a 50-Ohm coaxial cable with “N”-type connectors.



Note: *When you connect the **PTX-DDS** to other devices, it is necessary to strictly follow the instructions given by the respective manufacturers, to avoid damages or danger situations.*



WARNING: **Electric shock hazard. Never handle the RF output connector when the machine is powered on and no load is connected. Injury or death may result.**

Ensure that the **POWER** switch on the front panel (see figure 6.1 - item [7]), and the switch on the rear panel are set to (see figure 6.2 - item [1]) “**OFF**”.

Connect the mains power cable to the MAINS terminal board on the rear panel (see figure 6.2 - item [1]).



Note : *The mains must be equipped with adequate ground connection properly connected to the machine. This is a pre-requisite for ensuring operator safety and correct operation.*

Connect your source audio (for example the mixer or STL output) to the suitable input connector. The PTX-DDS offers a number of input choices, L+R, MPX or even digital; see the connectors description for details.

5.2 First power-on and setup

Follow this procedure upon first power-on and after making changes to the configuration of the transmitter in which the amplifier is integrated.



Note : *Standard factory settings are RF power output Off (**Pwr OFF**) and output power set to upper limit (unless otherwise specified by customer).*

5.2.1 Power-on

Question:

The equipment is turn off?

Answer:

- When you have performed all of the connections described in the previous paragraph, power on the amplifier using the suitable power switch on the rear panel (figure 6.2 - item [1]). Power on the pilot exciter switch on the front panel (figure 6.1 - item [7]). Ensure that the **ON** light turns on (see figure 6.1 - item [2]). Start up informations should appear briefly on the display, quickly followed by the main readings (figure 7.5 - chap.7.4.1). If RF output is disabled, these readings will be zero.

5.2.2 Frequency lock check

Question:

The equipment doesn't work correctly?

Answer:

- Ensure that the **LOCK** light turns on (see figure 6.1 - item [1]). It indicates the PLL is locked to working frequency, wait at least 15 seconds from the power on of **PTX-DDS**.

5.2.3 Power check

Question:

The equipment doesn't work correctly at the power set up?

Answer:

- Ensure that the **INTERLOCK** light turns off (see figure 6.1 - item [2]). It indicates that no external interlock signal inhibites the delivering power from exciter.
- Ensure that the **F.BACK** light turns off (see figure 6.1 - item [10]). In counter case indicates the foldback function is operating (automatic reduction of the delivered RF power). To restore the right operation, connect a proper load, or antenna, to the exciter.

- Check current **RF** output setting and enable output (if not already enabled) following menu path **Admin** ⇒ **RfSet** ⇒ **Pwr** ⇒ **ON** (chap. 7.4.3.1). Otherwise is possible enable the output power directly from main menu (chap. 7.4.1). Output power can also be set in a Pwr OFF condition; in this condition, (Fwd) output power reading on the display will be 0 (zero), that will be delivered the moment you switch back to Pwr ON state.
- Check output power level and set to maximum level (if not already set to maximum) from the Power Setup Menu, which you can call up by pressing these keys in the order: **Admin** ⇒ **RfSet** ⇒ **Pwr** ⇒ **P.Out** (chap. 7.4.3.1). In alternative is possible adjust the output power directly from main menu (chap. 7.4.1).

Use **RfSet** menu to set the desired amplifier output power, whereas the forward power value shown on the display (**Forward: xxx.x W**) gives actual output power reading, **and may be lower than set power if an Automatic Gain Control is in limited-power mode.**



IMPORTANT: *The transmitter incorporates Automatic Gain Control and output power is modulated based on the power level set by the user and actual operating conditions, such as temperature, reflected power and other parameters. Drive power must be kept steady at maximum output power capacity. Please read section 5.3 for more details of RF power modulation.*

5.2.4 Changing the Power Good alarm threshold

Change Forward Power Good alarm setting **PgFWD** from the **Admin** ⇒ **PgSet** menu as required (factory setting is 50%).

Please read section 7.4.3.2 for more details.

5.2.5 Changing the internal dip-switch configuration

To change the dip-switch configuration open the upper cover; switch off the equipment (if it power on) and disconnect the mains power cable, then unscrewing all the screw present. Remove the cover and identify the panel card (see figure below); configure the dip-switch referred to the own necessity.

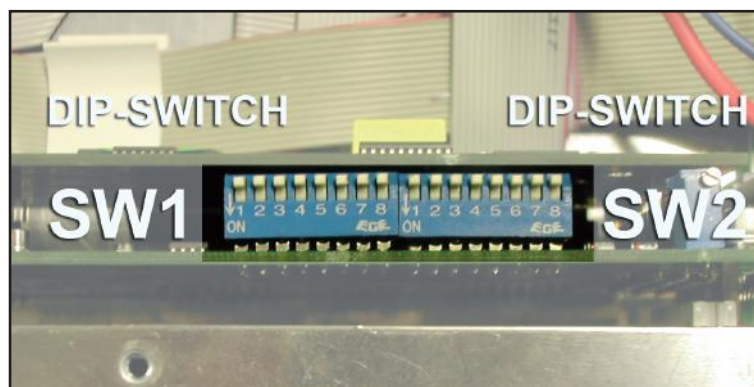

Figure 5.1

Dip-Switch	Set ON	Set OFF
1 (SW1)	- I ² C Bus disconnected. - Analogic Input 5 activated. - Analogic Input 6 activated.	- I ² C Bus connected. - Analogic Input 5 deactivated. - Analogic Input 6 deactivated.
2 (SW1)	Not used	Not used
3 (SW1)	Not used	Not used
4 (SW1)	- Mains Alarm on analogic input 6 activated	- Mains Alarm on analogic input 6 disactivated
5 (SW1)	- RLY1 and RLY2 enabled for power good output.	- RLY1 and RLY2 enabled for ON/OFF output.
6 (SW1)	- RLY1 output activated for reflected power good signalling.	- RLY1 output activated for audio alarm signalling.
7 (SW1)	Not used	Not used
8 (SW1)	Not used	Not used
1 (SW2)	- Vmeter bar in kHz	- Vmeter bar in "%"
2 (SW2)	Not used	Not used
3 (SW2)	Not used	Not used
4 (SW2)	Not used	Not used
5 (SW2)	Not used	Not used
6 (SW2)	Not used	Not used
7 (SW2)	Not used	Not used
8 (SW2)	Not used	Not used

Table 5.1: Dip-Switch configurations

5.2.6 How to enable Local mode

Question:

The equipment don't accept command through Control knob?

Answer:

- Check current mode setting and enable **Local mode** (if not already enabled) following menu path **Admin** ⇒ **PgSet** ⇒ **Loc** ⇒ **Local** (chap. 7.4.3.2): if left disabled, the machine will not accept the next commands.

5.2.7 How to enable Remote mode

If you wish to use the telemetry control feature, enable Remote control in the **Admin** ⇒ **PgSet** ⇒ **Loc** ⇒ **Local** menu (see section 7.4.3.2 for details).



Note : In the **Remote** mode the control knob, except **Remote/Local** (for switching back to Local mode), are disabled. Operating parameter readings are available.

5.2.8 Changing the external dip-switch configuration

To change the external dip-switch configuration; switch off the equipment (if it power on) and disconnect the mains power cable, then unscrewing all the screws present.

Remove the equipment from the rack and identify the bottom panel (see figure below); configure the dip-switch referred to the own necessity.

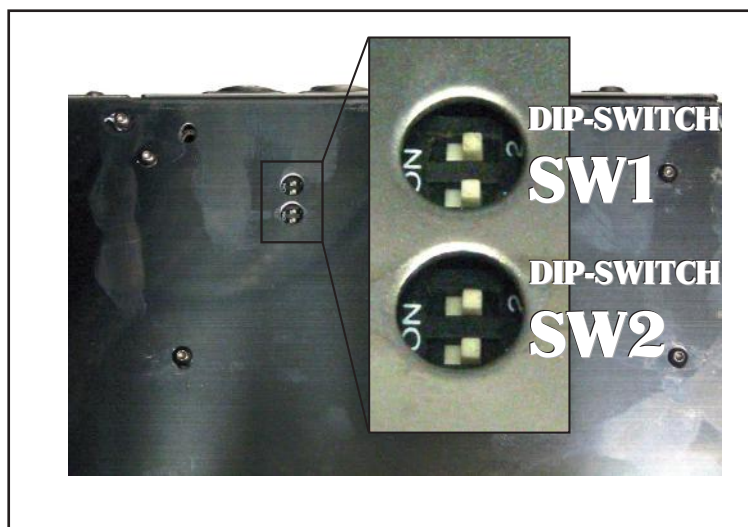

Figure 5.2

Dip-Switch	ON position	OFF position
1 & 2 (SW1)	L&R Input Impedance 600 Ω	L&R Input Impedance 10 kΩ
1 & 2 (SW2)	L&R Input Attenuation 12 dB	L&R Input Attenuation 0 dB

Tabelle 5.2: *Dip-Switch configurations*

6 External Description

This section describes the components found on the front and rear panel of **PTX-DDS**.

6.1 Front Panel

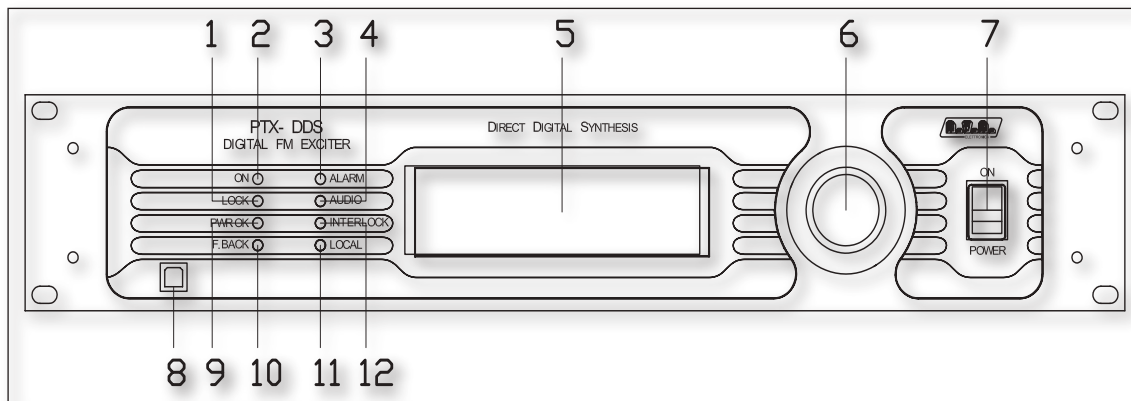

Figure 6.1

- | | |
|---|--|
| <ul style="list-style-type: none"> [1] LOCK [2] ON [3] ALARM
 [4] AUDIO
 [5] DISPLAY [6] ENCODER [7] POWER [8] USB
 [9] PWR OK [10] FOLDBACK [11] LOCAL
 [12] INTERLOCK | <p>Green LED, it is lit on when the PLL is locked to working frequency.</p> <p>Green LED, it is lit on when the exciter is switched on.</p> <p>Red LED, it is lit on in presence of transmitter failure in case of hardware alarms (for example communication lack between the modules). In case the LED flashing, it indicates the temperature alarm.</p> <p>Red LED, it is lit on when in case of audio lack below the thresholds set up in ALSET menu (see chap 7.4.3.11).</p> <p>Liquid Crystal Display, supports both graphics (240x64 pixels).</p> <p>Software control knob and button</p> <p>Power switch.</p> <p>USB connector for upgrades and communications with TELECON software.</p> <p>Green LED, it is lit on when the delivering output power get over the thresholds of PGset set up in PGSET menu (see chap 7.4.3.2).</p> <p>Yellow LED, it is lit on when the foldback function is operating (automatic reduction of the delivered RF power).</p> <p>Yellow LED, it is lit on when the exciter is set in Local status (see chap 7.4.3.2). In case the LED flashing, it indicates communications ahead between exciter and TELECON software.</p> <p>Red LED, it is lit on when exciter is not delivering power because inhibited by an interlock signal.</p> |
|---|--|

6.2 Rear Panel

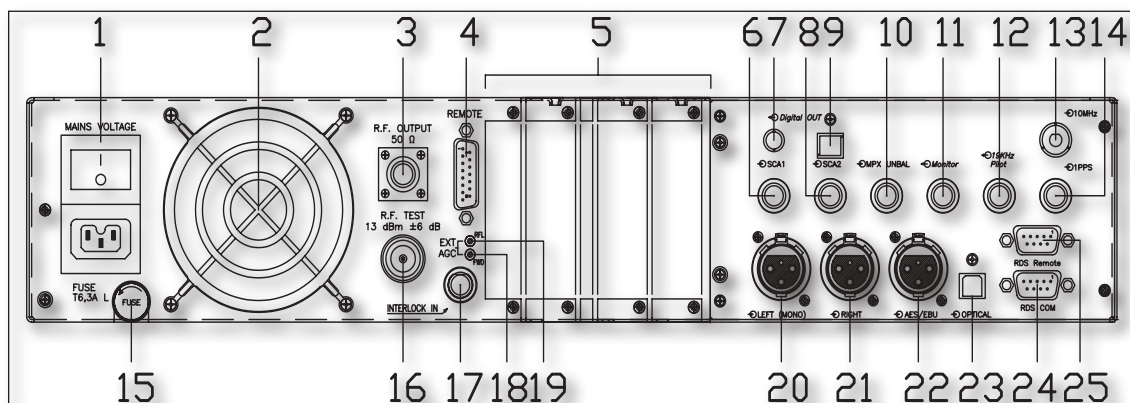

Figure 6.2

[1] PLUG	Mains power plug and Mains power switch.
[2] FAN	Forced cooling fan.
[3] RF Output	RF output connector, N-type, 50Ω.
[4] Remote	DB15 connector for telemetry of the machine.
[5] SLOT	Slot allocation for the options.
[6] SCA1	BNC input connector, SCA1 unbalanced.
[7] DIGITAL OUT	Not available (reserved for future uses).
[8] SCA2	BNC input connector, SCA2 unbalanced.
[9] DIGITAL OUT	Not available (reserved for future uses).
[10] MPX UNBAL	BNC input connector, MPX unbalanced.
[11] MONITOR	BNC output connector for internal MPX signal monitoring.
[12] 19 kHz pilot	BNC output connector for output tone control, may be used to synchronise external devices (such as RDS coder).
[13] 10MHz	Optional BNC input connector for carrier synchronism signal from external devices (such as GPS receiver).
[14] 1PPS	BNC connector for TTL signal input of 1PPS (such as GPS receiver).
[15] FUSE	Power supply fuse (6.3AT/250V/5x20).
[16] RF TEST	BNC output connector for test output at 30 dB below carrier.
[17] INTERLOCK IN	BNC connector for interlock. In case of central conductor is connected to ground, the transmitter is placed into forced standby mode.
[18] EXT AGC FWD	Trimmer for automatic gain control based on external signal of forward power.
[19] EXT AGC RFL	Trimmer for automatic gain control based on external signal of reflected power.
[20] LEFT (MONO)	XLR input connector for left or mono channel .
[21] RIGHT	XLR input connector for right channel .
[22] AES/EBU	XLR input connector for AES/EBU digital audio input.
[23] Optical	TOS-LINK connector for digital audio input in optical fiber.
[24] RDS Com	DB9 connector for RDS data serial communication.
[25] RDS Remote	DB9 connector for electromechanical remote interface.

6.3 Rear Panel

6.3.1 Remote

Type: Female DB15



1	Ext Rem	Interlock input, disables tx if connected to ground
2	Ext Fwd Pwr	Analogue input for forward power from external amplifier
3	GND	GND
4	Analogue Input 5	(0 - 5V) or I ² C bus SDA (*)
5	Analogue Input 3	(0 - 5V)
6	Analogue Input 1	(0 - 5V)
7	RLY 2 Out	Digital output. Normally open relay contact; it is closed to ground according to a preset on/off time when exciter state changes from ON to OFF (*)
8	GND	GND
9	GND	GND
10	Ext Rfl Pwr	Analogue input for reflected power from external amplifier
11	Analogue Input 6	(0 - 5V) or I ² C bus SCL or mains alarm input signalling (*)
12	Analogue Input 4	(0 - 5V)
13	Analogue Input 2	(0 - 5V)
14	GND	GND
15	RLY 1 Out	Digital output. Normally open relay contact; it is closed to ground according to a preset on/off time when exciter state changes from OFF to ON. Otherwise the states of this contact have the following meanings: power good signalling or audio alarm signalling (*)

(*) : the function is determined by dip-switches SW1 and SW2 on the panel card (see chap. 5.2.8 for details).

7. Operating System

The exciter is controlled by a microprocessor system. Software operations may be grouped into two broad categories: start-up and normal operation.

7.1 Using the encoder

The interaction between the user and the exciter's control software is performed using the encoder.

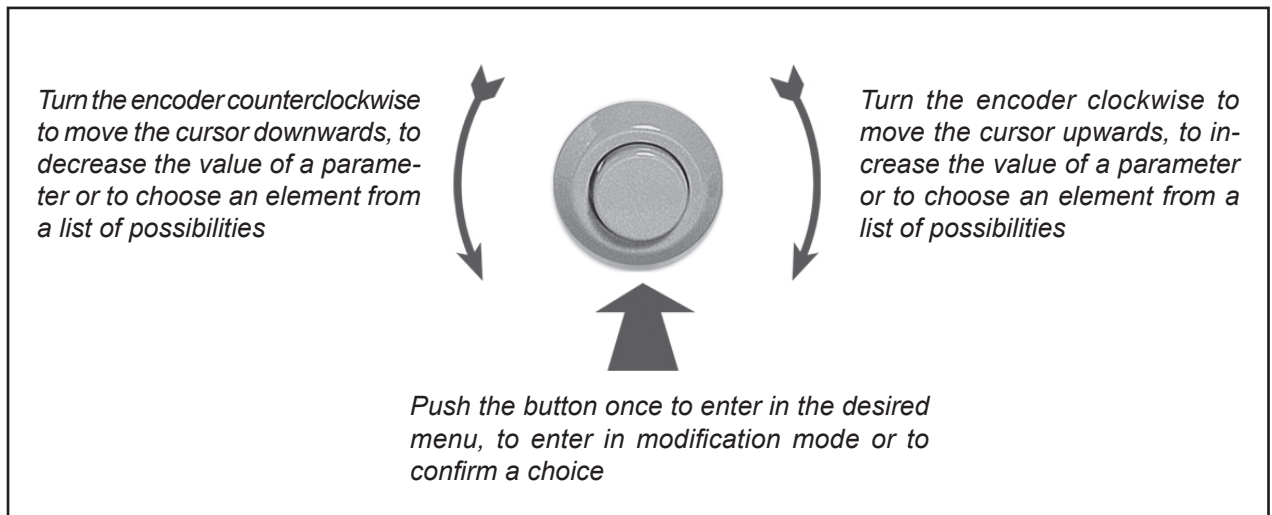

Figure 7.1

The possible operations that you can carry out on the encoder are:

- **rotation:** moves the cursor shown on the display; if you turn the encoder to the left (counterclockwise), the cursor moves downwards, if you turn it right the cursor moves upwards; it also permits to increase or diminish the parameters (turning the encoder left diminishes the parameter, turning it right increases it) or to select an item from a list of options. The rotation of encoder causes the lighting of the display, in case it is not been lighted.
- **pushing:** push the button once when the cursor is on the name of a menu to enter in that menu, push it when the cursor is on the name of a parameter to enter in modification mode (the cursor starts blinking); after the modification of a parameter, push the button to save the new value. The pushing of encoder causes the lighting of the display, in case it is not been lighted.

After having modified the value of a parameter, the cursor goes on blinking for approximately 10 seconds, waiting for confirmation from the user. If the user doesn't confirm the new value (i.e., the button is not pressed), the cursor stops blinking and remains on the selected parameter.

If no controls are operated during 2 minutes, the exciter returns to the default menu (see chap. 7.4.1), and after 5 minutes of inactivity the display lighting will be turning off.

7.2 Start-up

Upon switch-on, a window that holds the RVR logo and machine informations appears on the display. The informations regards the firmware release and the programming table.



Note: during the start-up operation don't press or turn the encoder. To reset the factory parameters read chapter 7.5.

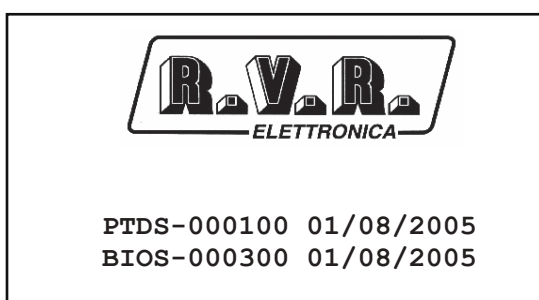

Figure 7.2

Otherwise, in substitution of the RVR logo, are available informations regarding equipment personalization, arranged on three rows of 16 characters.

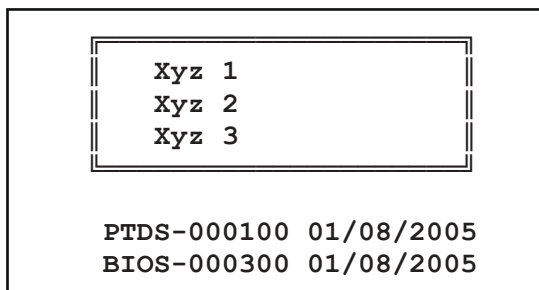

Figure 7.3

After approximately 10 seconds this screen is replaced with the default screen (see chap. 7.4.1).

7.3 Operating System

The **PTX-DDS** menu system consists of a default menu and set of administration menus.

The logic of the organization of the display is represented in the figures belows.

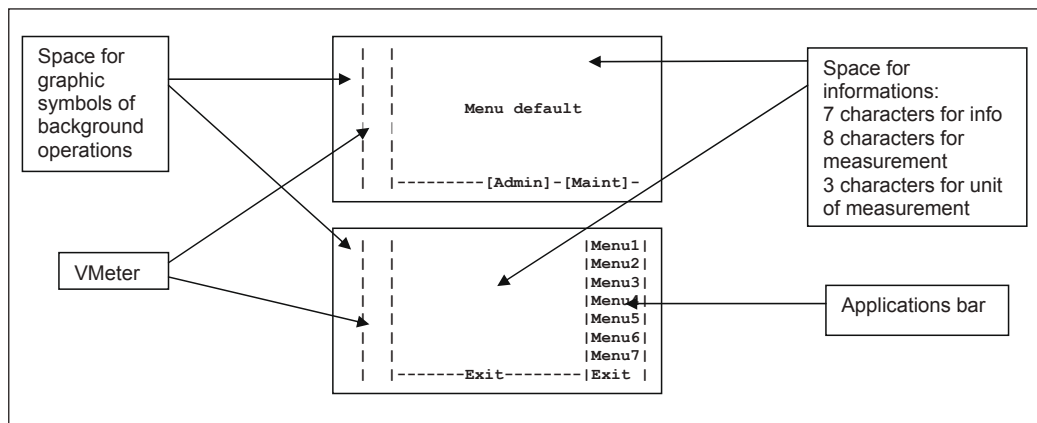

Figure 7.4

7.3.1 Common menu elements

In normal operation the equipment introduces default menu where are visualized the fundamental working parameters and comes characterizes two menu levels:

`Maint` Maintenance level where the equipment measures are only visualized, the operation parameters cannot be modified.

`Admin` Management level where are present all the equipment settings.







The visualization menu and the measure description can be available in several languages, depending the version.

7.3.1.2 Input modulation deviation bar (Vmeter)

The modulation sent to DDS is displayed as vertical bar in the left portion of the screen. The visualization of the bars in kHz or in percentage is determined by dip-switch SW2 on the panel card (see chap. 5.2.8 for details)

7.3.1.3 Graphic symbols

This graphic bar, placed on the left portion of the screen, shown the information icons relates to communication through TELECON.

-  Icon for signalling the IIC communication
-  Icon for signalling the RS232 communication
-  Icon for signalling the happened audio commutation on one of the two secondary channels
-  Icon for signalling the happened power reduction during SFN operation
-  Icon for signalling the presence of the internal or external signal reference of 10MHz.
-  Icon for signalling the detection of SPB490 data in RDS signal reception.

7.4 Menu Organization

7.4.1 Default menu (MAIN)

This is an information screen; it shows the main amplifier measures, most of this cannot be modified. Only RF Status, Frequency and Power Output are quickly modifiable from this menu.

If the illumination of the display is turned off, the first pressure or rotation of the encoder cause the lighting.

To change the editable parameters press the encoder, turn until the indicator is highlighted on the desired menu and then press again to confirm. The setting of the value is now possible by the rotating of the encoder.

After having modified the value of a parameter, the cursor goes on blinking for approximately 10 seconds, waiting for confirmation from the user. If the user doesn't confirm the new value (i.e., the button is not pressed), the cursor stops blinking and remains on the selected parameter.

To access to the Maintenance submenus (chap. 7.4.2) or to the Administrator submenus (see chap. 7.4.3) press the encoder, turn until the indicator is highlighted on the desired menu and then press again to confirm.

If no controls are operated through the encoder during 2 minutes, the exciter returns to this menu and after 5 minutes of inactivity the display lighting will be turning off.

```

| | RF Status: Off
| | Frequency: 000.000 MHz
| | Power Out: 000 %
| | Forward : 000.0 W
| | Reflected: 000.0 W
| | Ch. Input: Analog
| | Lev.Input: +00 +00 dBu
| |----- ---[Admin]-[Maint]-
    
```

Figure 7.5

- RF Status Visualization of the equipment power status
- Frequency Visualization of the working frequency
- Power Out Visualization of the output power expressed in percentage
- Forward Visualization of the forward power expressed in Watt
- Reflected Visualization of the reflected power expressed in Watt
- Ch. Input Visualization of the source on input audio channel that is generating modulation
- lev. Input Visualization of the audio level necessary to obtain the 100% of FM deviation expressed in dBu or dBfs

7.4.2 Maintenance menu (Maint)

Under this menu are available detailed information regarding the status of the equipment, most of these cannot be modified but are only visualized.

Turning the encoder, you can move the cursor to the next submenu label, while its informations and measures appears in the centre of the window.

To return to the default menu (see chap. 7.4.1), rotate the encoder until the "EXIT" label is highlighted, then press to exit the Maintenance submenu.

In alternative you can avoid to use the encoder for about 2 minutes to return to the default menu (see chap. 7.4.1) automatically.

7.4.2.1 RF measures submenu (RFmea)

This menu provides general information on the RF measures of the exciter.

	RF	: On		
	Freq.	: 000.000Mhz		
	FWD	: 0.0 W		
	RFL	: 0.0 W		
	RDS	: On		
	SFN	: On		
	FSK	: On		
	Maint	-----		

Figure 7.6

RF	Visualization of the equipment power status
Freq	Visualization of the working frequency
Fwd	Visualization of the forward power expressed in Watt
Rfl	Visualization of the reflected power expressed in Watt
RDS	Visualization of the internal RDS status
SFN	Visualization of the reduction power status for isofrequencies application
FSK	Visualization of the FSK status

7.4.2.2 Power amplifier measures submenu (PAm_{ea})

This menu provides general information on the power amplifier measures.

```

| |VPA   : 00.0  V | | |
| |IPA   : 00.0  A | |
| |VCO   : 00.0  V | |
| |Temp. : + 00  °C | |
| |      |          | |
| |ExtFWD:000.0  % | |
| |ExtRFL:000.0  % | |
| |Maint-----| |
    
```

Figure 7.7

VPA	Visualization of the feeding voltage of power amplifier expressed in Volt.
IPA	Visualization of the absorbed current of power amplifier expressed in Ampere.
VCO	Visualization of the voltage applied to VCO section expressed in Volt.
Temp .	Visualization of the amplifier module temperature expressed in degrees centigrade.
ExtFWD	Visualization of the forward power supplied by external amplifier expressed in percent.
ExtRFL	Visualization of the reflected power supplied by external amplifier expressed in percent.

7.4.2.3 Audio level submenu (AuLev)

This menu provides general information on the input audio level measures of the exciter.

	Ana. R: +00.0 dBr	
	Ana. L: +00.0 dBr	
	Dig. R: +00.0 dBr	
	Dig. L: +00.0 dBr	
	MX/SCA: +00.0 dBr	
	Maint-----	

Figure 7.8

Ana. R	Visualization of the right analogic channel level expressed in decibel (dBr).
Ana. L	Visualization of the left analogic channel level expressed in decibel (dBr).
Dig. R	Visualization of the left digital channel level expressed in decibel (dBr).
Dig. L	Visualization of the left digital channel level expressed in decibel (dBr).
MX/SCA	Visualization of the composite channel level expressed in decibel (dBr).

7.4.2.4 Audio control submenu (AuCnt)

This menu provides general information on the audio control measures of the exciter.

```

| |Clip. :OFF | | |
| |ClipLR:+00.0 dB | |
| |Clip X:+00.0 dB | |
| | | | |
| |Ph.Ana:+(L = R) | |
| |Ph.Dig:+(L =-R) | |
| |PhsMpx:-( MPX ) | |
| |Maint-----| |
    
```

Figure 7.9

Clip	Visualization of the clipper status
ClipLR	Visualization of the clipping level regulation for the right and left channels expressed in decibel.
Clip X	Visualization of the clipping level regulation for the composite channel expressed in decibel.
PhsAna	Visualization of the analogic channels phase modality.
PhsDig	Visualization of the digital channels phase modality.
PhsMPX	Visualization of the composite channel phase modality.

7.4.2.5 Board control submenu (BdCnt)

This menu provides general information on the exciter control adjustments of the exciter.

```

| |Input :Analog | |
| |Mode A:Mono | |
| |Mode D:Auto | |
| |Mode X:Stereo | |
| |Preemp: 50 uS | |
| |PilLev:+00.0 dB | |
| |PilPhs:+00.0 Deg| |
| |Maint-----| |

```

Figure 7.10

Input	Visualization of the audio input modality or the automatic rescuer activation.
Mode A	Visualization of the coder modality in analogic operation.
Mode D	Visualization of the coder modality in digital operation.
Mode X	Visualization of the coder modality in composite operation.
Preemp	Visualization of the preemphasis selection expressed in microseconds.
PilLev	Visualization of the level correction adjustment of the pilot generated expressed in decibel.
PilPhs	Visualization of the level correction adjustment of the pilot generated expressed in degrees.

7.4.2.6 Output level submenu (OuLev)

This menu provides general information on the output level measures.

```

| |Dig. R:+00.0 dBf| | |
| |Dig. L:+00.0 dBf| |
| | | | |
| |Monit.:+00.0 dBu| |
| | | | |
| |Pilot :+00.0 dBu| |
| |Maint-----| |
    
```

Figure 7.11

- Dig. R Visualization of the ouput level for the right digital channel expressed in decibel (dBfs).
- Dig. L Visualization of the ouput level for the left digital channel expressed in decibel (dBfs).
- Monit. Visualization of the ouput level for the Monitor channel expressed in decibel (dBu).
- Pilot Visualization of the pilot tone level expressed in decibel (dBu).

7.4.2.7 I.T.U. and A.G.C status Submenu (ITUst)

This menu provides general information on the ITU (International Telecommunications Union) and AGC (Automatic Gain Control) setups.

```

| |ITU   :On      | |
| |ITUlev:+00.0 dB | |
| |ITUadj:+00.0 dBr| |
| |AGC   :OFF    L&R| |
| |AGC LR:+00.0 dB | |
| |AGC   :OFF    MPX| |
| |AGC X:+00.0 dB | |
| |Maint-----| |

```

Figure 7.12

ITU	Visualization of the ITU functionality status.
ITUlev	Visualization of the ITU level expressed in decibel.
ITUadj	Visualization of the ITU level adjustment expressed in decibel (dBr).
AGC	Visualization of the intervention speed selection for the left and right channels.
AGC LR	Visualization of the intervention level for the left and right channels expressed in decibel.
AGC	Visualization of the intervention speed selection for the composite channel.
AGC X	Visualization of the intervention level for the composite channel expressed in decibel.

7.4.2.8 RDS status submenu (RDSst)

This menu provides general information on the RDS (Radio Data System) setups.

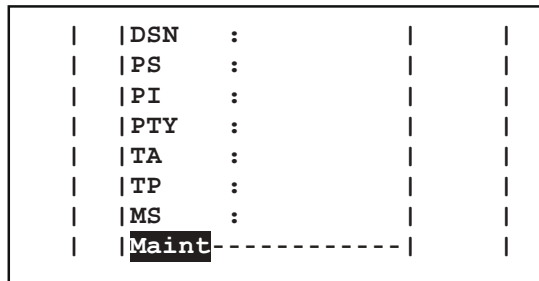

Figure 7.13

- DSN Visualization of the DSN put on the air (Data Source Name).
- PS Visualization of the text put on the air (Program Service).
- PI Visualization of the code put on the air (Program Identification).
- PTY Visualization of PTY (Program TYpe) status.
- TA Visualization of TA (Traffic Announcement) status.
- TP Visualization of TP (Traffic Program identification) status.
- MS Visualization of MS (Music/Speech) status.

7.4.2.9 External status submenu (EXTst)

This menu provides general information on the external analogic status.

	V1	:	0.00	V		
	V2	:	0.00	V		
	V3	:	0.00	V		
	V4	:	0.00	V		
	V5	:	Disabled			
	V6	:	Disabled			
	MAINS	:	Disabled			
	Maint	:	-----			

Figure 7.14

V1	Visualization of the input voltage on pin 6 of REMOTE connector expressed in Volts (max 5 V).
V2	Visualization of the input voltage on pin 13 of REMOTE connector expressed in Volts (max 5 V).
V3	Visualization of the input voltage on pin 5 of REMOTE connector expressed in Volts (max 5 V).
V4	Visualization of the input voltage on pin 12 of REMOTE connector expressed in Volts (max 5 V).
V5	Visualization of the input voltage on pin 4 of REMOTE connector expressed in Volts (max 5 V) or if disabled for IIC function.
V6	Visualization of the input voltage on pin 11 of REMOTE connector expressed in Volts (max 5 Volts) or if disabled for IIC function.
MAINS	Visualization of the MAINS input status if enabled on pin 11 of REMOTE connector

7.4.2.10 Alarms list submenu (AlmLt)

This menu provides general information on the last twenty alarms stored in a non volatile memory from the exciter.

In case the buffer is full, the previous alarms stored will have replaced with the new one, normally it visualized the last alarm saved in memory.

To change the alarm displayed press the encoder, turn until the indicator is highlighted on the “Alarm” label and then press again to confirm. Select one of the twenty alarms choose itself from the list of alarms 1 ... 20 using the encoder.

If the user confirm or doesn’t confirm the new value (i.e., the button is not pressed), the cursor stops blinking and remains on the first alarm stored.

To erase all the stored events use again the encoder, move cursor to “RESET” and confirm reset operation.

To exit from this submenu rotate the encoder until the “EXIT” label is highlighted, then press the encoder to confirm and return to Maintenance submenu navigation.

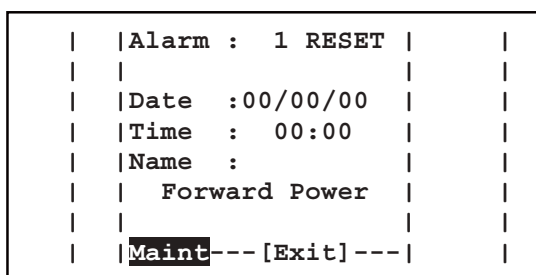

Figure 7.15

Alarm	Visualization and selection of the stored alarm number.
Reset	Selection for the alarms reset, this operation erases all stored events.
Date	Visualization of the alarm record date expressed as dd/MM/yy.
Time	Visualization of the alarm record time expressed as HH:mm.
Name	Visualization of the of stored alarm name.

7.4.2.11 Firmware informations submenu (Info)

This menu provides general information on the firmware installed and jumper setting in the exciter.



Note: if the version isn't supported is displayed "!!!ERROR!!!" (i.e.: after a new release firmware upgrade).

```

| |Bios:BIOS-000300 | |
| |App. :PTDS-000100 | |
| |Pan. :PDDS-000100 | |
| |Aud. :TRDP-000100 | |
| |Tab :PDDS-0150-01| |
| |Jumper: | |
| |12345678 12345678| |
| |Maint-----| |

```

Figure 7.16

Bios	Visualization of the bios release code.
App	Visualization of the application release code.
Pan.	Visualization of the panel release code.
Aud.	Visualization of the TRDSP release code.
Tab	Visualization of the configuration table code.
Jumper	Visualization of the status for the sixteen jumpers present on panel card (see chap 5.2.8). In case some jumpers is not been enabled, a "X" label appears in place of the number.

7.4.2.12 Modem informations submenu (InfoM)

This menu provides general information on the modem in case it is installed.

```
| |SCN:+393359609600| |
| |Nam:I TIM      | |
| |SigLev:-99     dB| |
| |Retry : 0      | |
| |Dial  :ATDT    | |
| |N. SMS: 50     | |
| |Stat.:Not in use| |
| |Maint-----| |
```

Figure 7.17

SCN	Visualization of the Service Centre Number.
Nam	Visualization of the customer number manager.
SigLev	Visualization of the GSM signal level received in antenna expressed in dB.
Retry	Visualization of the SMS transmission attempts in case of alarms.
Dial	Visualization of the initialisation string used by modem.
N. SMS	Visualization of the number of SMS that the SIM card can store.
Stat.	Visualization of the modem status.

7.4.3 Administration menu (Admin)

Under this menu are available advanced information regarding the status of the equipment and most of these can be modified.

Turning the encoder, you can move the cursor to the next submenu label, while its informations and measures appears in the centre of the window.

To return to the default menu (see chap. 7.4.1), rotate the encoder until the "EXIT" label is highlighted, then press to exit the Maintenance submenu.

In alternative you can avoid to use the encoder for about 2 minutes to return to the default menu (see chap. 7.4.1) automatically.

To access to the several submenus present press the encoder, turn until the indicator is highlighted on the desired editable parameters and then press again to confirm. To exit from this submenu rotate the encoder until the "EXIT" label is is highlighted, then press the encoder to confirm and return to Administration submenu navigation.

To change the editable parameters press the encoder, turn until the indicator is highlighted on the desired parameter label and then press again to confirm. The setting of the value is now possible by the rotating of the encoder.

After having modified the value of a parameter, the cursor goes on blinking for approximately 10 seconds, waiting for confirmation from the user. If the user doesn't confirm the new value (i.e., the button is not pressed), the cursor stops blinking and remains on the selected parameter.

7.4.3.1 RF setting submenu (RFset)

This menu provides general the RF setting of the exciter.

```

| |RF      :On      | |
| |Freq.  :000.000Mhz| |
| |F.Step:000      kHz| |
| |P.Out  :000      % | |
| |Rise t:000      Sec| |
| |FWD   : 0.0     W | |
| |RFL   : 0.0     W | |
| |Admin---[Exit]---| |
    
```

Figure 7.18

RF	Selection of the equipment power status. The status can be set ON (RF power output enabled) or OFF (RF power output disabled).
Freq	Selection of the working frequency. In case that the end of scale comes reached during the setting, you will bring back to beginning of scale. This editable parameter is expressed in megahertz.
F.Step	Selection of the step, for the regulation of the working frequency expressed in kilohertz. The adjustment of the value is available in step of 1, 10, 100 or 1000 kHz.
P.Out	Selection of the ouput power percentage desired from 0 (output power disabled) to 100%.
Rise t	Selection of the duration time regarding the power ascent ramp. The adjustment of the value is available step of 1 s from 0 to 10 s.
FWD	Visualization of the forward power expressed in Watt.
RFL	Visualization of the reflected power expressed in Watt.

7.4.3.2 Power general submenu (PGset)

This menu provides the Power Amplifier setting of the exciter.

```

| |Status:Local      | |
| |Pg FWD:000      % | |
| |Pg RFL:000      % | |
| |RLY1 :On        | |
| |RLY2 :On        | |
| |PPSsig:Present  | |
| |GPSsig:Present  | |
| |Admin---[Exit]---| |
  
```

Figure 7.19

Status	Selection of the equipment mode of operation. The status can be set “Local” (all settings included in the software are available, whereas the telemetry inputs are inhibited) or “Remote” (no changes may be made from equipment menus, and telemetry inputs are enabled).
Pg FWD	Selection of the threshold level for “forward power good” signal. Level is expressed as percentage of set power level. The activation of power good is on when PTX-DDS actual output power exceeds this percentage of nominal power. For example: assuming that power set in the default menu is 70% of machine rated power (i.e.: PTX100DDS 70% x 100W = 70W) and PG1 is set to 80% in the menu under discussion, the PG1 output at PIN 9 of the telemetry card will be on when actual output power exceeds (i.e.: PTX100DDS 80% x 70W = 56W).
Pg RFL	Selection of the threshold level for “reflected power good” signal. Level is expressed as percentage of set power level. The activation of power good is on when PTX-DDS actual output power exceeds this percentage of nominal power. Pg RFL operates on the same logic as Pg FWD.
RLY1	Visualization of the “Relay 1” status on the DB15 interface (Pin 15).
RLY2	Visualization of the “Relay 2” status on the DB15 interface (Pin 7).
PPSsig.	Visualization of the PPS signal status coming from the TRDSP board.
GPSsig.	Visualization of the GPS signal status coming from the GPS option.

7.4.3.3 Audio regulation submenu (AuREG)

This menu provides the audio level setting of the exciter.

When the exciter is set in STEREO mode from the BdSet menu (see chap. 7.4.3.5), the same level adjustment is forced on both channels.

The enabling for SCA operation is dependent also from the selection into the BdSet menu (chap. 7.4.3.5).

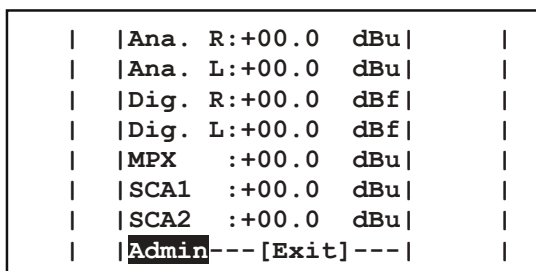

Figure 7.20

- Ana. R Selection of the right analogic channel level expressed in decibel. The adjustment of the level is available in step of 0.1 dBu ±12.5 dBu.
- Ana. L Selection of the left analogic channel level expressed in decibel. The adjustment of the level is available in step of 0.1 dBu ±12.5 dBu.
- Dig. R Selection of the left digital channel level expressed in decibel. The adjustment of the level is available in step of 0.1 dBfs from 0 to -25.0 dBfs.
- Dig. L Selection of the left digital channel level expressed in decibel. The adjustment of the level is available in step of 0.1 dBfs from 0 to -25.0 dBfs.
- MPX Selection of the composite channel level expressed in decibel. The adjustment of the level is available in step of 0.1 dBu ±12.5 dBu.
- SCA1 Selection of the SCA1 (Single Connector Attachment) channel level expressed in decibel. The adjustment of the level is available in step of 0.5 dBu from -30 to +13 dBu. In OFF position the channel is disabled.
- SCA2 Selection of the SCA2 (Single Connector Attachment) channel level expressed in decibel. The adjustment of the level is available in step of 0.5 dBu from -30 to +13 dBu. In OFF position the channel is disabled.

7.4.3.4 Audio setting submenu (AuSet)

This menu provides the audio control setting of the exciter.

	Clip. :OFF		
	ClipLR:+00.0 dB		
	Clip X:+00.0 dB		
	Ph.Ana:(L = R)+		
	Ph.Dig:(L =-R)+		
	Ph.Mpx:(MPX)-		
	Admin---[Exit]---		

Figure 7.21

- Clip Selection of the clipper modality. The status can be set OFF (Clipper disabled), RL (Clipper enabled for Left and Right Channels), MPX (clipper enabled for composite channel) or MPX+RL (Clipper enabled for all channels).
- ClipLR Selection of the clipping level regulation for the right and left channels expressed in decibel. The adjustment of the level is available in step of 0.1 dB \pm 12.5 dB.
- Clip X Selection of the clipping level regulation for the composite channel expressed in decibel. The adjustment of the level is available in step of 0.1 dB \pm 12.5 dB.
- Ph.Ana Selection of the analogic channels phase modality. It maybe normal or inverted (convenient when measuring “Sub to Main”). The status are reproduced in the table below.
- Ph.Dig Selection of the digital channels phase modality. It maybe normal or inverted (convenient when measuring “Sub to Main”). The status are reproduced in the table below.
- Ph.MPX Selection of the composite channel phase modality. It maybe normal or inverted (convenient when measuring “Sub to Main”). The status are reproduced in the table below.

Status	Description
+ (L = R)	Normal phase. Right channel in phase with Left channel
+ (L = -R)	Normal phase. Right channel 180° out-of-phase referred to Left channel
- (L = R)	Inverted phase. Right channel in phase with Left channel
- (L = -R)	Inverted phase. Right channel 180° out-of-phase referred to Left channel
+ (MPX)	Normal phase for the MPX channel
- (MPX)	Inverted phase for the MPX channel

Table 7.1

7.4.3.5 Board setting submenu (BdSet)

This menu provides the exciter control setting. In case of passage from Mono to Stereo modality, the left channel adjustments are replicated on the right channel.

```

| |Input :Analog      | | |
| |Mode A:Mono       | | |
| |Mode D:Auto       | | |
| |Mode X:Stereo     | | |
| |Preemp: 50 uS     | | |
| |PilLev:+00.0 dB  | | |
| |PilPhs:+00.0 Deg | | |
| |Admin---[Exit]---| | |
    
```

Figure 7.22

- Input Selection of the audio input modality or the automatic rescuer activation. The status can be set Analog (analogic inputs), Digital (digital inputs), MPX (composite input) or Auto A-D-X (automatic input rescuer). For details see chap. 7.6.
- Mode A Selection of the coder modality in analogic operation. The status are reproduced in the table below.
- Mode D Selection of the coder modality in digital operation. The status are reproduced in the table below.
- Mode X Selection of the coder modality in composite operation. The status are reproduced in the table below.
- Preemp Selection of the preemphasis selection expressed in microseconds. The adjustment of the value is available in step of 0, 25, 50 and 75 μ S.
- PilLev Selection of the level correction adjustment of the pilot generated expressed in decibel. The adjustment of the level is available in step of 0.1 dB \pm 12.5 dB referred to -20 dB.
- PilPhs Selection of the level correction adjustment of the pilot generated expressed in degrees centigrade. The adjustment of the level is available in step of 0.1 $^{\circ}$ \pm 12.5 $^{\circ}$.

	Mode A	Mode D	Mode X	Description
Stereo	x	x	x	Stereophonic mode
Stereo + RDS	x	x	x	Stereophonic with RDS mode
Mon L	x	x		Monophonic mode with only left channel enabled
Mon L +RDS	x	x		Monophonic with RDS mode and only left channel enabled
MonL+R	x	x		Monophonic mode with right & left channels enabled
MonL+R +RDS	x	x		Monophonic with RDS mode and right & left channels enabled
Mono			x	Monophonic mode
Mono +RDS			x	Monophonic with RDS mode
Auto		x		Automatic mode selection
Auto +RDS		x		Automatic mode selection with RDS
Stereo +SCA	x	x	x	Stereophonic mode and SCA enabled
Stereo +SCA +RDS	x	x	x	Stereophonic with RDS mode and SCA enabled
Mon L +SCA	x	x		Monophonic mode with SCA and only left channel enabled
Mon L +SCA +RDS	x	x		Monophonic with RDS mode, SCA and only left channel enabled
MonL+R +SCA	x	x		Monophonic mode with SCA and right & left channels enabled
MonL+R +SCA +RDS	x	x		Monophonic with RDS mode, SCA and right & left channels enabled
Mono +SCA			x	Monophonic mode and SCA enabled
Mono +SCA +RDS			x	Monophonic with RDS mode and SCA enabled
Auto +SCA		x		Automatic mode selection with SCA enabled
Auto +SCA +RDS		x		Automatic mode selection with RDS and SCA enabled

Table 7.2

7.4.3.6 Output regulation submenu (OuReg)

This menu provides the output level setting of the exciter.

```

| |Dig. R:+00.0 dBf| | |
| |Dig. L:+00.0 dBf| |
| | | | |
| |Monit.:+00.0 dBu| |
| | | | |
| |Pilot :+00.0 dBu| |
| | | | |
| |Admin---[Exit]---| |
  
```

Figure 7.23

- Dig. R Selection of the ouput level for the right digital channel expressed in decibel. The adjustment of the level is available in step of 0.1 dBfs from -12.5 to 0 dBfs.
- Dig. L Selection of the ouput level for the left digital channel expressed in decibel. The adjustment of the level is available in step of 0.1 dBfs from -12.5 to 0 dBfs.
- Monit. Selection of the ouput level for the Monitor channel expressed in decibel. The adjustment of the level is available in step of 0.1 dBu from -12.5 to +6 dBu.
- Pilot Selection of the ouput level for the pilot tone channel expressed in decibel. The adjustment of the level is available in step of 0.1 dBu from -12.5 to +6 dBu.

7.4.3.7 I.T.U. and A.G.C setting Submenu (ITU)

This menu provides the ITU (International Telecommunications Union) and AGC (Automatic Gain Control) setting of the exciter.

```

| | ITU   :On      | | |
| | ITUlev:+00.0 dB | | |
| | ITUadj:+00.0 dBr| | |
| | AGC   :OFF    L&R| | |
| | AGC LR:+00.0 dB | | |
| | AGC   :OFF    MPX| | |
| | AGC X:+00.0 dB | | |
| | Admin---[Exit]---| | |
    
```

Figure 7.24

- ITU Selection of the ITU functionality status. The status can be set ON (ITU enabled) or OFF (ITU disabled).
- ITUlev Visualization of the ITU level expressed in decibel.
- ITUadj Selection of the ITU level adjustment expressed in decibel (dBr). The adjustment of the level is available in step of 0.1 dBr ±3 dBr.
- AGC Selection of the intervention speed selection for the left and right channels. The status can be set OFF (intervention disabled), SLOW (slow intervention speed), MIDDLE (medium intervention speed) or FAST (rapid intervention speed).
- AGC LR Selection of the intervention level for the left and right channels expressed in decibel. The adjustment of the level is available in step of 0.1 dB from 0 to +12 dB.
- AGC Selection of the intervention speed selection for the composite channel. The status can be set OFF (intervention disabled), SLOW (slow intervention speed), MIDDLE (medium intervention speed) or FAST (rapid intervention speed).
- AGC X Selection of the intervention level for the composite channel expressed in decibel. The adjustment of the level is available in step of 0.1 dB from 0 to +6 dB.

7.4.3.8 RDS setting submenu (RDS)

The menu provides the RDS (Radio Data System) setting of the exciter. The enabling for RDS operation is dependent also from the selection into the BdSet menu (chap. 7.4.3.5).

```

| |RDS   :ON   | |
| |
| |Level  :   0   mV | |
| |
| |Phase  :  0.0   ° | |
| |
| |Admin---[Exit]---| |

```

Figure 7.25

RDS	Visualization of the RDS modality. The status can be displayed ON (RDS coder enabled) or OFF (RDS coder disabled).
Level	Selection of the pilot tone level at 57KHz expressed in millivolt. The adjustment of the level is available in step of 1 mVpp from 0 to 150 mVpp.
Phase	Selection of the pilot tone phase at 57KHz expressed in degrees. The adjustment of the phase is available in step of 0.1 ° from 0 to 360 °.

7.4.3.9 SFN submenu (SFN)

This menu provides the SFN (Single Frequency Network) setting of the exciter.

```

| |P.Red.:ON      | |
| |PpsInt:100    min| |
| |PpsRec: 10    min| |
| |GpsInt:200    min| |
| |GpsRec: 0     min| |
| |Power : 50    % | |
| |Delay : 0.000 us| |
| |Admin---[Exit]---| |
    
```

Figure 7.26

Enable	Selection of the SFN modality in case of synchrony lack. The status can be displayed ON (power reduction enabled) or OFF (power reduction disabled). If SFN function is not enabled on the TRDSP, the parameter comes forced to OFF position.
PpsInt	Selection of the power reduction intervention in case of PPS signal lack expressed in minutes. The adjustment of the value is available in step of 1 min from 0 to 240 min.
PpsRec	Selection of the power recovery intervention in case of PPS signal lack. The adjustment of the value is available in step of 1 min from 0 to 240 min.
Gpsint	Selection of the power reduction intervention in case of GPS signal failure. The adjustment of the value is available in step of 1 min from 0 to 240 min.
GpsRec	Selection of the power recovery intervention in case of GPS signal failure. The adjustment of the value is available in step of 1 min from 0 to 240 min.
Power	Selection of the power reduction proportion in case of activation function expressed in percentage. The adjustment of the value is available in step of 1 % from 0 to 100 %.
Delay	Selection of the audio delay for synchronization expressed in milliseconds. The adjustment of the value is available in step of 100 μ S from 0 to 10 mS. If SFN function is not enabled on the TRDSP, the parameter comes written as Disabled.

7.4.3.10 FSK submenu (FSK)

This menu provides the FSK (Frequency Shift Keying) setting of the exciter.

```

| |Enable:OFF      | | |
| |Offset: 10    kHz| | |
| |ReTime: 10    min| | |
| |Code  :RVR COD | | |
| |              | | |
| |              | | |
| |              | | |
| |Admin---[Exit]---| | |

```

Figure 7.27

- Enable Selection of the FSK modality. The status can be displayed ON (FSK function enabled) or OFF (FSK function disabled).
- Offset Selection of the frequency offset of character transmission expressed in kilohertz. The adjustment of the value is available in step of 1 kHz from 10 to 90 kHz.
- ReTime Selection of the repetition time for Morse code transmission expressed in minutes. The adjustment of the value is available in step of 1 min from 10 to 240 min.
- Code Selection of the Morse code sended (typically composed from a character, three figures and two characters).

7.4.3.11 Alarms setting submenu (AlSet)

This menu provides the alarm setting of the exciter.

	FWD	:00%	000s	
	RFL	:00%	000s	
	Audio	:00kHz	000s	
	Mains	:	000s	
	ExtFWD	:00%	000s	
	ExtRFL	:00%	000s	
	Admin	---	[Exit]---	

Figure 7.28

- FWD Selection of the alarm activation level in case of forward power lack expressed in percentage. The adjustment of the level is available in step of 1 % from 0 (alarm disabled) to 99 %.
- RFL Selection of the alarm activation level in case of reflected power lack expressed in percentage. The adjustment of the level is available in step of 1 % from 0 (alarm disabled) to 99 %.
- Audio Selection of the alarm activation level in case of audio lack expressed in percentage. The adjustment of the level is available in step of 1 % from 0 (alarm disabled) to 99 %.
- Mains Selection of the alarm activation time in case of mains power lack expressed in seconds. The adjustment of the value is available step of 1 s from 0 to 240 s.
- ExtFWD Selection of the alarm activation level in case of external forward power lack expressed in percentage. The adjustment of the level is available in step of 1 % from 0 (alarm disabled) to 99 %.
- ExtRFL Selection of the alarm activation level in case of external reflected power lack expressed in percentage. The adjustment of the level is available in step of 1 % from 0 (alarm disabled) to 99 %.
- s Selection of the alarm activation time, referred to the several entries, expressed in seconds. The adjustment of the value is available in step of 1 s from 0 to 240 s.

In the following is shown the operating logic of an alarm:

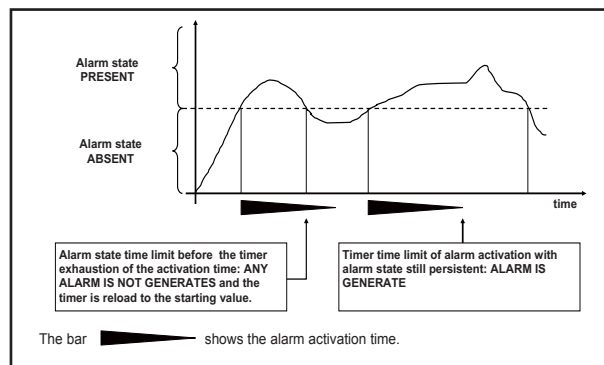

7.4.3.12 Alarms rescuer submenu (Aresc)

This menu provides the alarm rescuer of the exciter. For more information about this menu, please read chapter 7.6.

```

| |Status:Disable | |
| |AnaLev:-00 dBr| |
| |DigLev:-00 dBr| |
| |MpxLev:-00 dBr| |
| |PilLev:-00 dBr| |
| |CngTmr:000s 000s | |
| |RecTmr:000m 000m | |
| |Admin---[Exit]---| |

```

Figure 7.29

Status	Visualization of the alarm rescuer status. The status can be displayed OK (correct function), WARNING (the audio reserve is not available), FAULT (only MPX signal is present) or Disable (function disabled).
AnaLev	Selection of the analogic threshold level adjustment expressed in decibel (dBr). The adjustment of the level is available in step of 0.2 dBr from -18 to 0 dBr.
Diglev	Selection of the digital threshold level adjustment expressed in decibel (dBr). The adjustment of the level is available in step of 0.2 dBr from -18 to 0 dBr.
MPXlev	Selection of the composite threshold level adjustment expressed in decibel (dBr). The adjustment of the level is available in step of 0.2 dBr from -18 to 0 dBr.
PILlev	Selection of the pilot tone threshold level adjustment expressed in decibel (dBr). The adjustment of the level is available in step of 0.2 dBr from -18 to 0 dBr.
CngTmr	Selection of the intervention times for the passing with lower priority expressed in seconds. The adjustment of the level is available in step of 1 s from 5 to 200 s. In --- position the parameter is disabled.
RecTmr	Selection the intervention times for the passing with upper priority expressed in seconds. The adjustment of the level is available in step of 1 s from 5 to 200 s. In --- position the parameter is disabled.

7.4.3.13 General setting submenu (GnSet)

This menu provides the general setting (as modem, serial interface, time, etc.) of the exciter.

```

| |Uart  :  1      | | |
| |Baud  : 9600   | |
| |Modem :Absent  | |
| |      |       | |
| |Lang. :English | |
| |Date  :00/00/00| |
| |Time  :00:00:00| |
| |Admin---[Exit]---| |
    
```

Figure 7.30

Uart	Selection of the address for I ² C and serial communications, selectable from 1 to 200.
Baud	Selection of the baud rate for the serial port data transfer, selectable between 1200, 2400, 4800, 9600, 19200 and 38400.
Modem	Selection of the modem modality. The status can be displayed “Present” (traditional PSTN modem function enabled), “GSM” (GSM modem function enabled) or “Absent” (modem function disabled).
Lang	Selection of the menu language.
Date	Selection of the date expressed as dd/MM/yy.
Time	Selection of the time expressed as HH:mm:ss.

7.5 Set up Reset

To reset completely the **PTX-DDS** to the factory set up, if necessary, follow the next instructions.

The user must hold pressed the encoder, therefore switch on the **PTX-DDS**, it will be displayed the following screen:

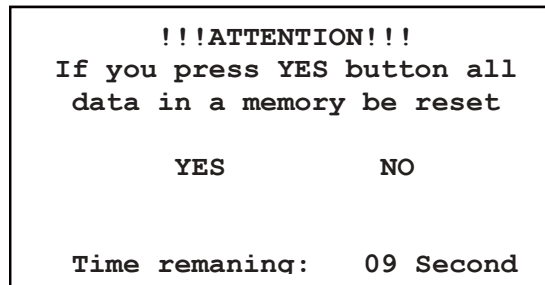

Figure 7.31

In order to make the reset, it is necessary to move the encoder until the “YES” label is highlighted, therefore press it. By pressing the encoder on the “NO” label the user is brought back to the normal start up (see chap.7.2).

In any case after 20 seconds, without selection, the user is brought back to the start up screen.

After you had pressed the “YES” label, when it is highlighted, will be displayed a new screen with the percentage information of restoring operation.

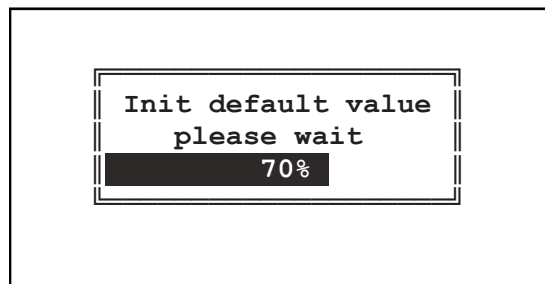

Figure 7.32

7.6 Audio Rescuer

7.6.1 Preliminary Considerations

The TRDSP card has available an Optical-AES/EBU digital input, two balanced analog inputs (audio channel left and right) for stereo broadcast, unbalanced MPX input scanned up to 100 kHz and 2 SCA adjustable inputs mixed in analogic with MPX input.

For automatic switching are considered three points:

- Signal level on analog audio input (L.A.). The reference threshold is calculated independently on left and right input as the value is relative to the input level set. The threshold refers to reading, so first of all audio processing such as PB, Preemphasis, Clipper, ITU or A.G.C.. The input signal is considered valid if both channels are valid. When you set the analogic CODER as MONO_L the level of the right channel is always considered valid.
- Signal level on digital audio AES/EBU, after conversion, independently the optical or balanced source (L.D.). The reference threshold is calculated independently on left and right input as the value is relative to the input level set. The threshold refers to reading, so first of all audio processing such as PB, Preemphasis, Clipper, ITU or A.G.C.. The input signal is considered valid if both channels are valid. When you set the digital CODER as MONO_L the level of the right channel is always considered valid.
- Signal level on MPX input, which contains the analogic sum of the three MPX, SCA1 and SCA2 unbalanced inputs. When this input is primary or secondary, the SCA inputs are automatically blocked to prevent measurements from the SCA (L.X.). The reference threshold is calculated in relative mode referred to the setted input level.
- Digital stream. It is found the consistency and validity of the digital texture by reading the FLAG status of the audio device (T.D.). To establish the validity of the texture are measured also the break for minute, which must be less than the parameter set by the user.
- 19KHz Tone. The presence of 19KHz pilot tone is continuously monitored on MPX input (T.P.). When you set the MPX CODER as MONO, the pilot tone is excluded from the aid algorithm.

7.6.2 Validity of signal sources

The following table defines the validity of sources in different configurations.

	Analogic Audio level	Digital Audio Level	MPX Audio Level	Digital Stream	Pilot Tone Plot
STEREO Analogic	R & L	----	----	----	----
MONO L Analogic	L	----	----	----	----
MONO L+R Analogic	R & L	----	----	----	----
STEREO Digital	----	R & L	----	----	----
MONO L Digital	----	L	----	----	----
MONO L + R Digital	----	R & L	----	----	----
STEREO + PLOT Digital	----	R & L	----	STREAM ERROR	----
MONO L + PLOT Digital	----	L	----	STREAM ERROR	----
MONO L + R + PLOT Digital	----	R & L	----	STREAM ERROR	----
Digital (0dB threshold)	----	PLL-LOCK	----	----	----
Digital (0dB threshold)	----	PLL-LOCK	----	STREAM ERROR	----
MPX – MONO	----	----	MPX	----	----

7.6.3 Selections of sources via MIXER parameter

The following table that sorts the sources depending on the MIXER setting; from the table is possible to learn when they can use SCA inputs and what kind of emergency signals are controlled.

	Digital	Analogic	MPX	SCA 1 & 2
0	Not used	1°	Not used	Utilizables
1	1°	Not used	Not used	Utilizables
2	Not used	Not used	1°	Utilizables
3	1°	2°	3°	Utilizables
4	2°	1°	3°	Utilizables
5	1°	3°	2°	Not utilizables
6	3°	1°	2°	Not utilizables
7	2°	3°	1°	Not utilizables
8	3°	2°	1°	Not utilizables
9	1°	2°	Not used	Utilizables
10	2°	1°	Not used	Utilizables
11	1°	Not used	2°	Not utilizables
12	Not used	1°	2°	Not utilizables
13	2°	Not used	1°	Not utilizables
14	Not used	2°	1°	Not utilizables

For further information see Board setting submenu (BdSet) on chapter 7.4.3.5.

7.6.4 Operation of rescuer

First of all, select the audio input modality or the automatic rescuer activation through Board setting submenu (BdSet).

	State 1	State 2	State 3
Mode 1	A (analogic)	-	-
Mode 2	-	D (digital)	-
Mode 3	-	-	X (MPX)
Mode 4	A (analogic)	D (digital)	X (MPX)
Mode 5	A (analogic)	X (MPX)	D (digital)
Mode 6	D (digital)	A (analogic)	X (MPX)
Mode 7	D (digital)	X (MPX)	A (analogic)
Mode 8	X (MPX)	A (analogic)	D (digital)
Mode 9	X (MPX)	D (digital)	A (analogic)

Then select the level, below which the rescuer enter in action, through Alarms rescuer submenu (Aresc).

When the rescuer enter in action or exit from alarm condition, the switching between inputs takes place according to the timetable set in the Alarms rescuer submenu (Aresc).

Alarm occurred: time from state 1 to 2 , and from state 2 to 3 is adjustable under CngTmr in the Alarms rescuer submenu (Aresc).

No alarm occurred: time from state 2 to 1 , and from state 3 to 2 is adjustable under RecTmr in the Alarms rescuer submenu (Aresc).

A brief graphic description of rescuer’s operation is given here below:

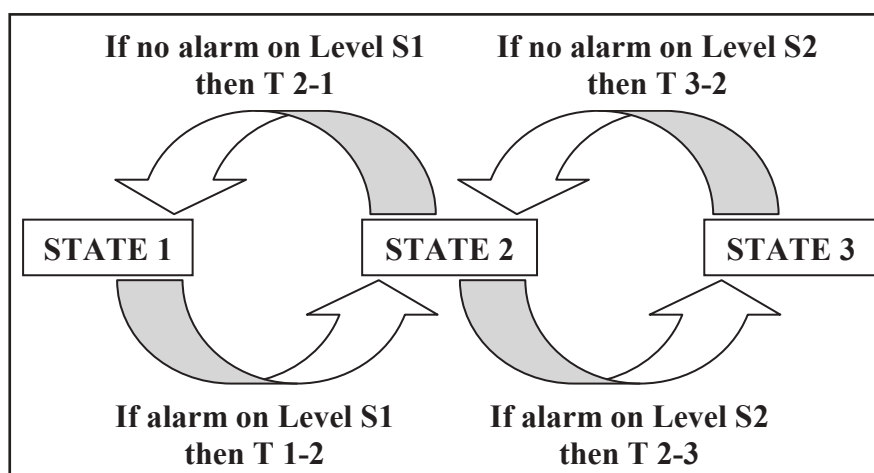

7.7 I.T.U.

The I.T.U. function is active only when the internal coder works, it has been implemented to monitor the output of complete MPX process. When you enable this function, the AGC is automatically switched off and the CLIPPER R & L function is added.

The I.T.U. function does not gain on input signal, but it is able to attenuate the input level until to 20dB.

In the intervention are included all the components present in the output like AUDIO, CARRIER, RDS and SCA. The corrective action is only on audio inputs, then the contribution of RDS and SCA will be offset by lowering the audio input.

You can change the ITU control reference respect to 0 of legislation in steps of 0.1dBr in the interval between 0dBr and 6dBr, this to adapt the legislation present in the different countries.

7.8 A.G.C. and Clipper

7.8.1 A.G.C. function for Analogic and Digital audio channel

The A.G.C. function (*Automatic Gain Control*) control in feedback the input level at the end of audio processing (Low Pass, Preemphasis, etc..) and needs to keep the audio signal at 0dBu level, avoiding to have signals continuously low or that continuously takes up the CLIPPER. The control is set with an absolute level (i.e.: 4dB), which indicates how many it can gain or attenuate this check.

The value range is adjustable from 0dB to 12dB, obviously the value of 0dB exclude the control while using 12dB completely uses completely the control.

The A.G.C. can be activated in 3 modes (Slow, Medium, Fast) and represents the speed at which very high signals are attenuated or very low audio signal are gained.

The contents of audio signal is not altered by this control, but it is only altered in amplitude.

This control works properly when accompanied by CLIPPER-ON function, which blocks the signal waiting of A.G.C. application.

7.8.2 A.G.C. function for MPX channel

The A.G.C. of MPX input works in identical mode to audio input but with a value range up to 6dB.

This control alters the level of SCA inputs of the same amount needed to correct the signal present on MPX. Furthermore, the control occurs on the sum of MPX and SCA.

7.8.3 Clipper function

The CLIPPER function cuts all signals above 0dB.

The Clipper on audio inputs is filtered to avoid compromising on pilot tone, RDS signal, and any SCA.

The Clipper on MPX input is for security, it cuts the signals in surplus but does not give any protection on pilot tone, RDS and SCA. The distortion of clipper is still contained within the 100 KHz of bandwidth allocated to this input.

8. Technical Specification

Parameters	Conditions	U.M.	PTX30-DDS
GENERALS			
Frequency range		MHz	87.5 + 108
Frequency programmability			From software, with 1 kHz steps
Rated output power		W	30
Modulation type			Direct Digital Synthesis
Operational Mode			Mono, Stereo, Multiplex
Ambient working temperature		°C	0 to + 50 (operational -10)
Frequency stability	WT from -10°C to 50°C	ppm	±1
Modulation capability		kHz	150
Pre-emphasis mode		µS	0, 50 (CCIR), 75 (FCC)
Spurious & harmonic suppression		dBc	> 80 (85 typical)
Asynchronous AM S/N ratio	Referred to 100% AM, with no de-emphasis	dB	≥ 60
Synchronous AM S/N ratio	Referred to 100% AM, FM deviation 75 kHz by 400Hz sine, without de-emphasis	dB	≥ 50
MONO OPERATION			
S/N FM Ratio	RMS @ ± 75 kHz peak, HPF 20Hz - LPF 23 kHz, 50 µS de-emphasis	dB	> 85 (typical 90)
	Qpk @ ± 75 kHz peak, CCIR weighted, 50 µS de-emphasis	dB	> 84
	Qpk @ ± 40 kHz peak, CCIR weighted, 50 µS de-emphasis	dB	> 78
Frequency Response	30Hz - 15kHz	dB	better than ± 0.5 dB (typical ± 0.2)
Total Harmonic Distortion	THD+N 30Hz - 15kHz	%	< 0.05 (Typical 0.03%)
Intermodulation Distortion	Measured with a 1 KHz and 1.3 KHz tones, 1:1 ratio, at FM 75 kHz	%	< 0.02
Transient intermodulation distortion	Measured with a 3.18 kHz square wave and a 15 kHz sine wave at 75 kHz FM	%	< 0.1 (typical 0.05)
MPX OPERATION			
Composite S/N FM Ratio	RMS @ ± 75 kHz peak, HPF 20Hz - no LPF, 50 µS de-emphasis	dB	> 75 (typical 79)
	Qpk @ ± 75 kHz peak, CCIR weighted, 50 µS de-emphasis	dB	> 70 (typical 72)
	Qpk @ ± 40 kHz peak, CCIR weighted, 50 µS de-emphasis	dB	> 67 (typical 69)
Frequency Response	30Hz - 53kHz	dB	± 0.2
	53kHz - 100kHz	dB	± 0.5
Total Harmonic Distortion	THD+N 30Hz - 53kHz	%	< 0.05
Intermodulation distortion	THD+N 53kHz - 100kHz	%	< 0.1
Intermodulation distortion	Measured with a 1 KHz and 1.3 KHz tones, 1:1, modulation at FM 75 kHz	%	< 0.05
Transient intermodulation distortion	Measured with a 3.18 kHz square wave and a 15 kHz sine wave at 75 kHz FM	%	< 0.1 (typical 0.05)
Stereo separation	400Hz - 5kHz	dB	> 70
	40Hz - 15kHz	dB	> 60
STEREO OPERATION			
Stereo S/N FM Ratio	RMS @ ± 75 kHz peak, HPF 20Hz - LPF 23 kHz, 50 µS de-emphasis, L & R demodulated	dB	> 80 (Typical 83)
	Qpk @ ± 75 kHz peak, CCIR weighted, 50 µS de-emphasis, L & R demodulated	dB	> 70 (Typical 72)
	Qpk @ ± 40 kHz peak, CCIR weighted, 50 µS de-emphasis, L & R demodulated	dB	> 67 (Typical 70)
Frequency Response	30Hz - 15kHz	dB	± 0.5
Total Harmonic Distortion	THD+N 30Hz - 15kHz	%	< 0.05
Intermodulation distortion	Measured with 1 KHz and 1.3 KHz tones, 1:1 ratio, modulation at FM 75 kHz	%	≤ 0.03
Transient intermodulation distortion	Measured with a 3.18 kHz square wave and a 15 kHz sine wave at 75 kHz FM	%	< 0.1 (typical 0.05)
Stereo separation	400Hz - 5kHz	dB	> 70
	40Hz - 15kHz	dB	> 60
Main / Sub Ratio	30Hz - 15kHz	dB	> 40 (typical 45)
SCA OPERATION			
Frequency response	40kHz - 100kHz	dB	± 0.5
AUDIO INPUTS			
Analog Left / MPX balanced	Connector		XLR F
	Type		balanced or externally unbalanced
	Impedance	Ohm	10 k or 600
	Input Level, Adjustment Range	dBu	-12.5 to +12.5
Analog Right balanced	Connector		XLR F
	Type		balanced or externally unbalanced
	Impedance	Ohm	10 k or 600
	Input Level, Adjustment Range	dBu	-12.5 to +12.5
Analog MPX unbalanced	Connector		BNC
	Type		unbalanced
	Impedance	Ohm	10 k
	Input Level, Adjustment Range	dBu	-12.5 to +12.5
Digital AES/EBU	Connector		XLR, AES/EBU 24-96 Khz
	Type		balanced
	Impedance	Ohm	75 or 110
	Input Level, Adjustment Range	Vpp	+3 to +10
Digital SPDIF Optical	Connector		TosLink F05 - EIAJ
Digital SPDIF Electrical	Connector		Cinch- RCA coaxial
	Impedance	Ohm	75
	Input Level, Adjustment Range	Vpp	+0.5 to +1
	Connector		2 x BNC
SCA/RDS	Impedance	Ohm	unbalanced
	Input Level, Adjustment Range	dBu	10 k
	Input Level, Adjustment Range	dBu	-12.5 to +12.5
OUTPUTS			
RF Output	Connector		N type
	Impedance	Ohm	50
RF Monitor	Connector		BNC
	Impedance	Ohm	50
Pilot output	Output Level	dB	approx. -30
	Connector		BNC
	Impedance	Ohm	> 4,7 k
MPX Monitor	Output Level	Vpp	1
	Connector		BNC
	Impedance	Ohm	>600
AUXILIARY CONNECTIONS			
Interlock	Connector		BNC
RS232 Serial Interface	Connector		DB9 F
RS485 Serial Interface	Connector		
Remote Interface	Connector		DB15F
Input 10 MHz	Connector		BNC
POWER REQUIREMENTS			
AC Power Input	AC Supply Voltage	VAC	115 / 230 ±15%
	AC Apparent Power Consumption	kVA	0.14
	Active Power Consumption	kW	0.07
	Power Factor		0.51
	Connector		IEC Standard
FUSES			
On PA Supply			1 External fuse 6,3 AT - 5x20 mm
MECHANICAL DIMENSIONS			
Physical Dimensions	Front panel width	mm	483 (19")
	Front panel height	mm	88 (3 1/2")
	Overall depth	mm	400 (15,7")
Weight		kg	13
OPTIONS			
Input 10 MHz		code	
GPS		code	
TELEMETRY-TELECONTROL SW			
Telecon			Yes
VARIOUS			
Cooling			Forced, with internal fan
Acoustic Noise		dBA	< 56
STANDARD COMPLIANCE			
Safety			EN 60215:1989 EN 60215/A1:1992-07 EN 60215/A2:1994-09
EMC			ETSI EN 301 489-11 V1.2.1 ETSI EN 301 489-11 V1.4.1
			ETSI EN 302 018-1 V1.1.1 ETSI EN 302 018-2 V1.1.1
Spectrum Optimization			

PTX100-DDS	PTX150-DDS	Notes
87.5 ± 108 From software, with 1 kHz steps 100	87.5 ± 108 From software, with 1 kHz steps 150	Continuously variable by software from 0 to maximum
Direct Digital Synthesis Mono, Stereo, Multiplex 0 to + 50 (operational -10) ±1 150 Stereo 0, 50 (CCIR), 75 (FCC) > 80 (85 typical) ≥ 60 ≥ 50	Direct Digital Synthesis Mono, Stereo, Multiplex 0 to + 50 (operational -10) ±1 150 Stereo 0, 50 (CCIR), 75 (FCC) > 80 (85 typical) ≥ 60 ≥ 50	Without condensing Meets or exceeds all FCC and CCIR rules Selectable by software Meets or exceeds all FCC and CCIR rules
> 85 (typical 90) >84 >78	> 85 (typical 90) >84 >78	
better than ± 0.5 dB (typical ± 0.2) < 0.05 (Typical 0.03%) < 0.02 < 0.1 (typical 0.05)	better than ± 0.5 dB (typical ± 0.2) < 0.05 (Typical 0.03%) < 0.02 < 0.1 (typical 0.05)	
> 75 (typical 79) > 70 (typical 72) > 67 (typical 69) ± 0.2 ± 0.5 < 0.05 < 0.1 < 0.05 < 0.1 (typical 0.05) > 70 > 60	> 75 (typical 79) > 70 (typical 72) > 67 (typical 69) ± 0.2 ± 0.5 < 0.05 < 0.1 < 0.05 < 0.1 (typical 0.05) > 70 > 60	
> 80 (Typical 83) > 70 (Typical 73) > 67 (Typical 70) ± 0.5 < 0.05 ≤ 0.03 < 0.1 (typical 0.05) > 70 > 60 > 40 (typical 45)	> 80 (Typical 83) > 70 (Typical 73) > 67 (Typical 70) ± 0.5 < 0.05 ≤ 0.03 < 0.1 (typical 0.05) > 70 > 60 > 40 (typical 45)	
± 0.5	± 0.5	
XLR F balanced or externally unbalanced 10 k or 600 -12.5 to +12.5	XLR F balanced or externally unbalanced 10 k or 600 -12.5 to +12.5	Selectable by internal switch 0.1 dB step variable by software
XLR F balanced or externally unbalanced 10 k or 600 -12.5 to +12.5	XLR F balanced or externally unbalanced 10 k or 600 -12.5 to +12.5	Selectable by internal switch 0.1 dB step variable by software
BNC unbalanced 10 k -12.5 to +12.5	BNC unbalanced 10 k -12.5 to +12.5	0.1 dB step variable by software
XLR, AES/EBU 24-96 KhZ balanced 75 or 110 +3 to +10	XLR, AES/EBU 24-96 KhZ balanced 75 or 110 +3 to +10	Selectable by internal switch 0.1 dB step variable by software
TosLink F05 - EIAJ Cinch- RCA coaxial 75 +0,5 to +1 2 x BNC unbalanced 10 k -12.5 to +12.5	TosLink F05 - EIAJ Cinch- RCA coaxial 75 +0,5 to +1 2 x BNC unbalanced 10 k -12.5 to +12.5	Selectable by internal switch 0.1 dB step variable by software
N type 50 BNC 50 approx. -30 BNC > 4,7 k 1 BNC >600 0	N type 50 BNC 50 approx. -30 BNC > 4,7 k 1 BNC >600 0	Referred to the RF output @ ±75 kHz peak FM, externally adjustable +12 / -6 dBu
BNC DB9 F DB15F BNC	BNC DB9 F DB15F BNC	for remote power inhibition (short is RF off) for modem and PC control software communication IIC + 8 analog / digital input For optional 10 MHz external synch
115 / 230 ±15% 0,21 0,12 0,55 IEC Standard	115 / 230 ±15% 0,27 0,15 0,54 IEC Standard	Internal switch
1 External fuse 6,3 AT - 5x20 mm	1 External fuse 6,3 AT - 5x20 mm	
483 (19") 88 (3 1/2") 400 (15,7") 15	483 (19") 88 (3 1/2") 400 (15,7") 15	19" EIA rack 2HE
		for PLL synchronizing purpose
Yes	Yes	Proprietary RVR
Forced, with internal fan < 56	Forced, with internal fan < 56	Leq 3 min @ 1 m
EN 60215:1989 EN 60215/A1:1992-07 EN 60215/A2:1994-09 ETSI EN 301 489-11 V1.2.1 ETSI EN 301 489-11 V1.4.1 ETSI EN 302 018-1 V1.1.1 ETSI EN 302 018-2 V1.1.1	EN 60215:1989 EN 60215/A1:1992-07 EN 60215/A2:1994-09 ETSI EN 301 489-11 V1.2.1 ETSI EN 301 489-11 V1.4.1 ETSI EN 302 018-1 V1.1.1 ETSI EN 302 018-2 V1.1.1	

9. Modules Identification

The **PTX-DDS** is made up of various modules linked to each other through connectors so as to make maintenance and any required module replacement easier.

9.1 Top View

The figure below shows the equipment top view with the various component pointed out

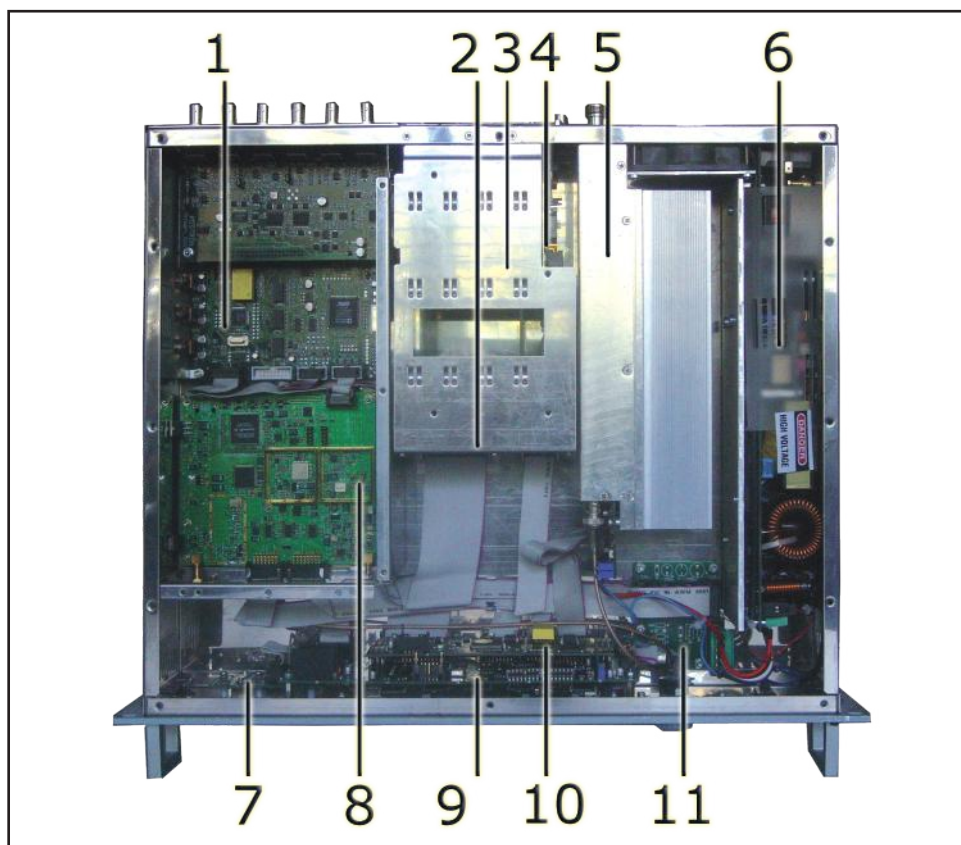

Figure 9.1

- | | | |
|------|-----------------------------------|--|
| [1] | TRDSP5 | TRDSP board |
| [2] | SL034TL1001 | TLM panel distribution card |
| [3] | SL034TL2002 | RS232 card |
| [4] | SL034IN2002 | Remote interface card |
| [5] | SLPA30WMOS02 + SL034BI1003 | Power amplifier and RF control card (30W version) |
| | SLPA150WMOS + SL034BI2003 | Power amplifier and RF control card (100W or 150W version) |
| [6] | PSL300DDS | Power supply card (28V 10A) |
| [7] | SL034IN1001 | USB connector card |
| [8] | SL174MD1001 | FM modulator card |
| [9] | SL034PC1004 | Panel card |
| [10] | SL034CP1001 | 16-bit CPU card |
| [11] | SL034PS1002 | Power supply distribution card |

9.2 Power supply unit

The **PTX-DDS** power supply unit is a switching-type unit whose +34 V main output powers the machine's RF amplifier. The power supply also features stabilizers for generating continuous +5 V, -15V, +8V and +18 V voltages for powering the other device circuits.

9.3 Power amplifier

The power amplifier is available in a 30W, 100W and 150W version.

The final power stage is enclosed in a fully shielded metal container fixed to the central part of the device.

The RF signal coming from the main board reached the pilot, is amplified and then sent to the final stage which takes care of final amplification up to 30, 100 or 150W (depending the model).

Amplification occurs in two stages, the first done with the BLF244, and the second with a BLF147.

Besides actual RF amplification, this circuit performs other functions:

- Checks output power level depending on the setting
- Reduces delivered power in presence of high-level reflected power
- Measures direct and reflected power by means of directional couplers
- Measures the current absorbed by the power amplifier
- Measures temperature
- Filters the pass low of the output RF signal

This board also features an RF sampling of approximately -13dBm RF with respect to the output, which is available on a BNC connector below the transmitter output connector. Sampling is useful for verifying the characteristics of the carrier, but not for checking those of the upper harmonics.

9.4 Panel Card

This card is located in the front end of the device and provides an interface between the CPU card and the remaining **PTX-DDS** cards.

This card handles all signals from/to LCD, Encoder, LED Indicators, Power Supply Card, Audio Mainboard and external telemetry card, in other words, all input/output signals of the CPU card.

The software denotes jumper positions as described in chapter. 5.2.8.

9.5 16-bit CPU Card

The CPU card is located at the front end of the device and is secured to the panel card.

This card is the heart of the transmitter as it handles and processes all information provided by the other cards and by other devices connected through the serial interface or the telemetry card.

The 1Mb Flash Memory enables firmware update through direct connection of **PTX-DDS** RS232 output to the serial port of a PC.

Card specifications are as follows:

- **Microprocessor:** 90F5436
- **Flash Memory size:** 1MBytes
- **Static RAM size:** 32KBytes
- **Communication Interface:** RS232-RS485 and I²C Bus
- **EEPROM size:** 2KBytes
- **Self-diagnosis LED:** 1 red led

9.6 TRDSP Card

The TRDSP is a DSP-based digital circuit that performs the following tasks:

- input selection, level adjustment and processing (filtering and preemphasis)
- stereophonic coding
- RDS (Radio Data System) signal generation.

The TRDSP accepts audio inputs in digital form (AES/EBU) or Left and Right analogue inputs that are immediately converted into digital format (A/D). A digital input is automatically selected when present, but analogue input selection can be forced with the appropriate software settings.

The MPX stereophonic signal (“Main”, “Sub” and 19 kHz subcarrier) is generated directly in digital form, starting with the Left and Right digital (or digitalised) channels.

The RDS is generated directly by DSP and then digitally added to the stereophonic audio signal. The messages transmitted by the RDS coder are programmed using a PC software supplied with the machine. It also possible to disable the internal RDS coder and use an external coder.

The TRDSP includes a support panel with the input and output connectors.

The key advantage offered by the TRDSP option is enhanced performance in terms of:

- Amplitude/frequency response (± 0.01 dB, 30 Hz - 15 kHz)
- Stereophonic separation (65 dB, 30 Hz - 15 kHz)
- Distortion ($< 0.03\%$)

In addition, the digitally processed signal enables frequency deviation limitation while avoiding the distortion issues typically experienced with analogue clippers.

At TRDSP output, the total signal (MPX + RDS) is converted into analogue form (D/A) and passed on to the standard up-converter section of **PTX-DDS**.