

# 1. Descrizione Software di Telecontrollo

## 1.1 Functioning

The program exploits the serial connection through RS232 with a modem for the connection to a remote RVR station.

Each RVR station is composed of several parts called "modules" that can be called sequentially in order to receive and send data. These data are interpreted in order to obtain the measurement value to which they refer.

The connection is always realized starting from the first module, either when the station is composed of several modules (TLC300, TLC2000, SCM) or when the station is composed of a single module (PTXLCD).

The maximum connection speed is 19200 baud when transmitting with a traditional telephonic line and 9600 baud when transmitting with a GSM telephone line.

## 1.2 Installation

- Insert the CD-ROM in the CD-ROM player.
- From the desktop, open "Program Manager".
- Double click on the CD-ROM player icon to display its content.
- If you are using Windows2000, double click on the program "setup\_telecon\_win2k.exe" to install the software
- If you are using Windows95, 98 or Me, double click on the program "setup\_telecon\_win9x.exe" to install the software
- It may be required to install the necessary drivers for the access to data, before installing the software.
- When the installation is completed, the "Tlc32bit" group which contains the programs: "Telecon 32bit" and "GSM Init" will be created, then the connection icons will appear on the Desktop.

### **System Requirements:**

- Windows 95 ®, Windows 98 ® either first or second edition, Windows ME ®, Windows NT ® and Windows 2000 ®.
- Processor:  
Intel Pentium ® 75 MHz or better.
- Minimum Memory required:  
16MB Ram.
- Minimum capacity on Hard Disk required:  
50Mb.

## 1.3 Esecution

Double click on the "Telecon 32bit" icon present on the desktop or select Telecon 32bit from the "Start" menu -> Programs -> TLC32bit -> ", in order to start the program.

### 1.3.1 How to choose and configurate a station

In the main window it is possible to choose the station you wish to call and edit the parameters that refer to communication.

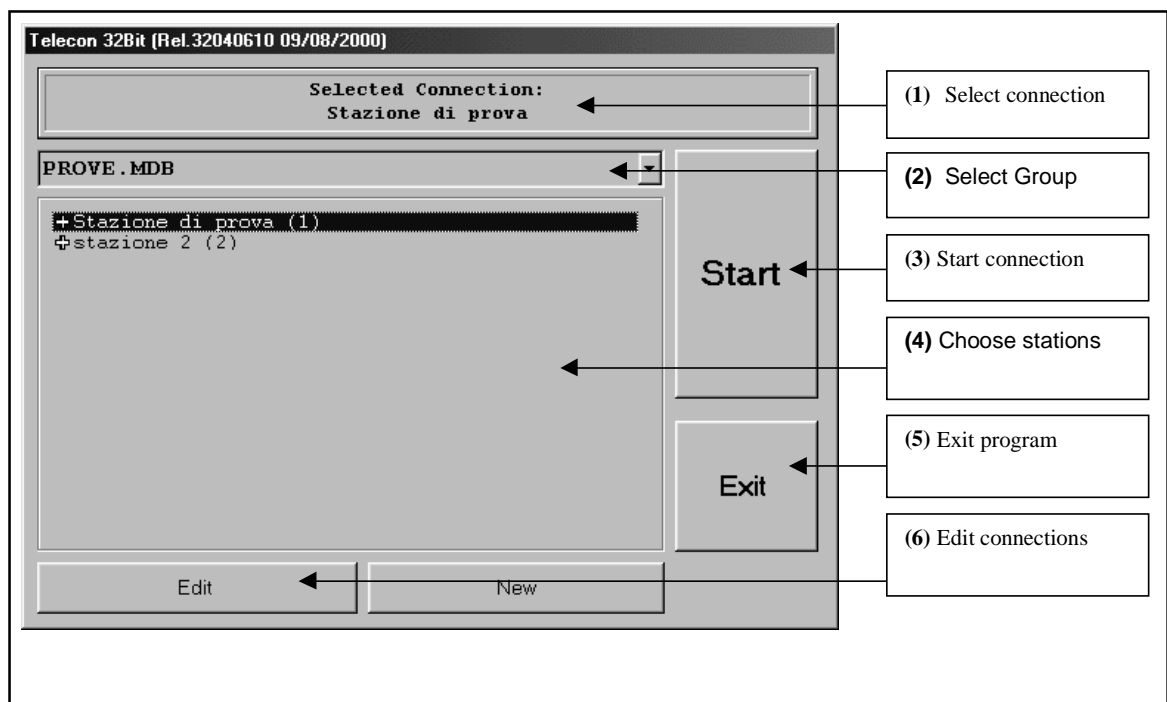

- The window showing the "Chosen connection " (1) indicates which station will be called when the "START" button is selected (3).
- When clicking on "Select Group" menu (2) it is possible to choose between the different groups of stations (if saved)
- The "START" button (3) launches the call to the station.
- The "EXIT" button (5) exits the program.
- When clicking on "Select stations" (4) it is possible to choose among the present stations which one will be called, the selection inside the window will then change (1).

When pressing the cross situated on the left side of the name of the station, the description of the station is displayed.

The station is composed of 2 menus:

- "Connection Configuration" containing the connection parameters (init string of the modem, telephone number, etc..),

- "Station Configuration" containing the composition of the station.

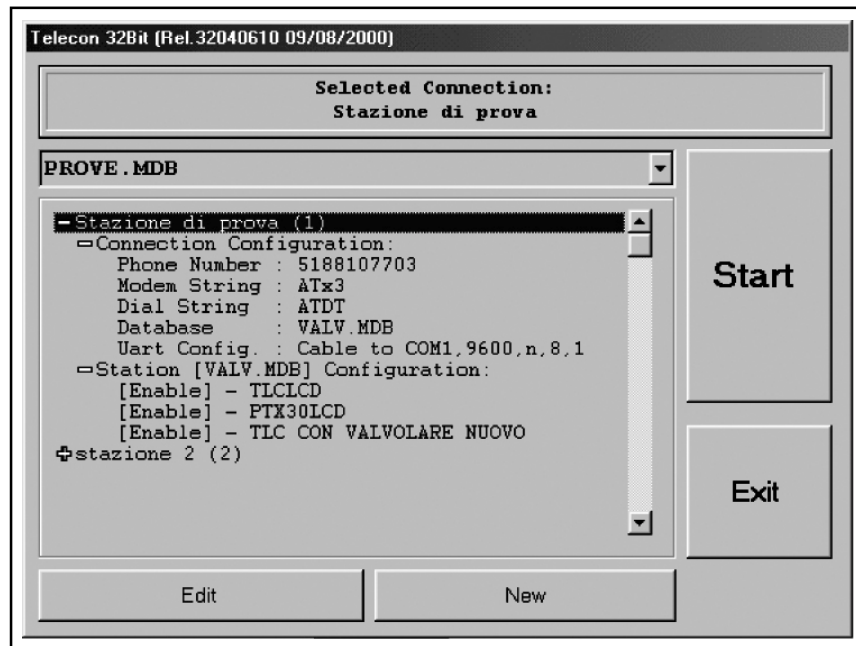

- When you click on the "Edit connections" button (6) the window shown in fig 3 is displayed, from there you can edit the different connection parameters of each station.

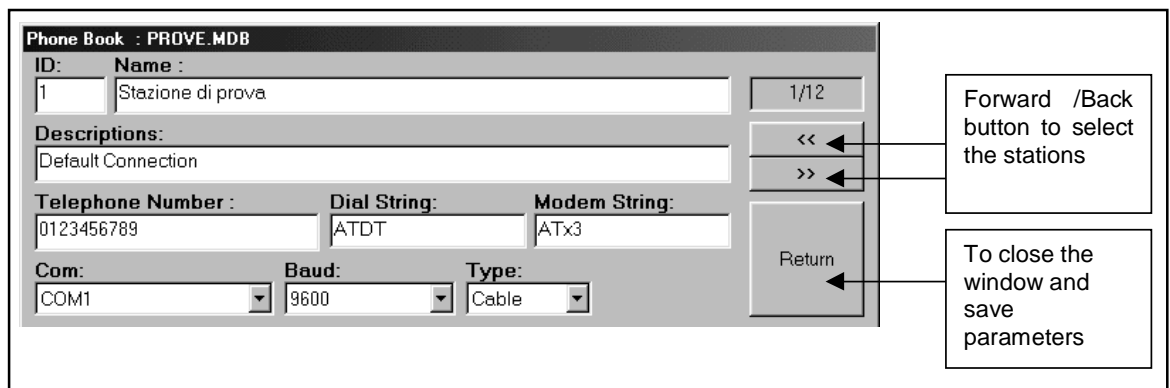

The first time you use the software, it is necessary to enter:

- The telephone number,
- The COM port used,
- the Baud rate,
- the type of connection (direct through cable, through telephonic modem or GSM).

In order to avoid functioning problems, we will not give instructions concerning stations

building. Please kindly contact R.V.R. S.p.A. if you wish to put additional stations.

### 1.3.2 Connection

When the station is selected, press "START" (3).



The connection window is displayed, and it will remain displayed until the connection is completed.

In case the telephone line is busy, it will be possible to make a new connection attempt by pressing the "Retry" button.

The "More Detail >>" button enables to get further information concerning the status of the station.

The "Exit" button brings you back to the "station selection" window.

## 1.4 Functioning

The program has 2 interfaces:

### 1.4.1 How to personalize

The first interface called "Personalization" is displayed when the station is connected.

This interface is easy to use and it enables the user to check, whenever he wants, the status of the station in a fast way (fig. refers to the personalization of a VJ25000).

Apart from the various indicators either analogical or digital and the alarm leds, there are also a few buttons that enable to select most frequently needed functions (switch on/off, alarm reset).

When pressing one of these buttons, the user is asked to confirm the current function selected.

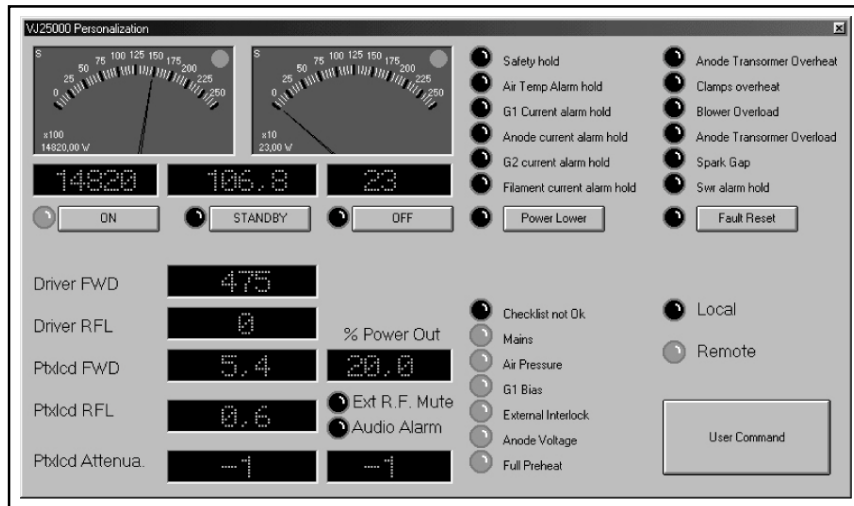

In order to change some levels such as attenuation of the inputs and the output power percentage of the PTXLCD, double click on the measurement that you wish to change and insert the new value required.

If you wish to create or modify the personalization, please refer to Chapter "Creation and editing of the personalization window".

### 1.4.2 Standard interface

Behind the Personalization window, there is the standard Telecon interface.

It is composed of 5 main areas:

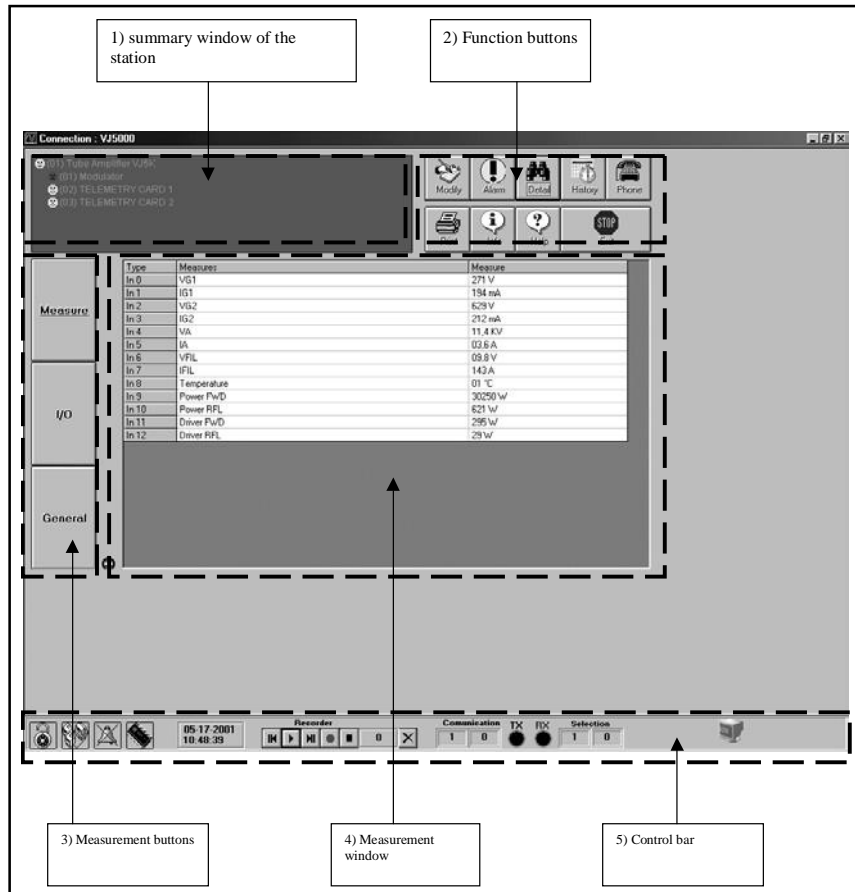

1) **Summary window of the station**



As you can understand from its name, it indicates the parts that compose the station (obviously as far as telemetry is concerned).

When you click on the components (modules), the window with the data concerning measurements are displayed (3).

## 2) Function of the different buttons



- "Alarm" button:

The "Alarm" button enables to open the window showing the chronological list of the alarms that may have appeared (only for SCM and TLC units).

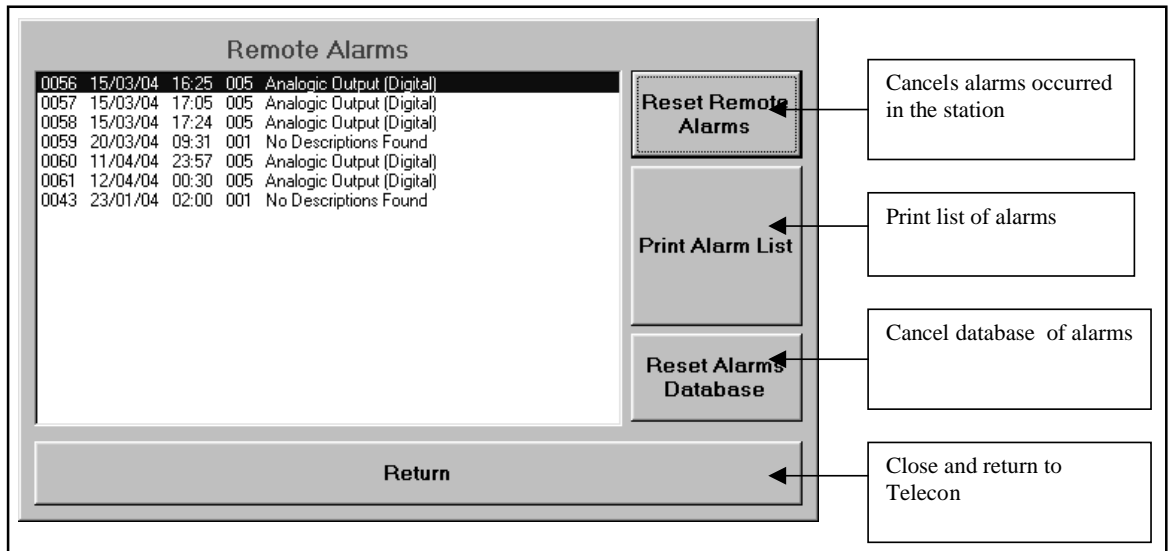

Apart from being saved in the station, the occurred alarms are included in the database of the station itself.



- "Detail" button:

The "Detail" enables to open the personalization (See point 10.4.1).



- "History" button:

The "History" button enables to open the window containing the schedule (this function is not available in this software version).



- "Print" button:

The "Print" button enables to print the status of the station: a page for each module with the different measurements as displayed on the measurement window (3).



- "Info" button:

The "Info" button enables to open a window in which it is possible to select the modules in order to get information concerning the software and hardware versions, the number of analogical and digital I/O.

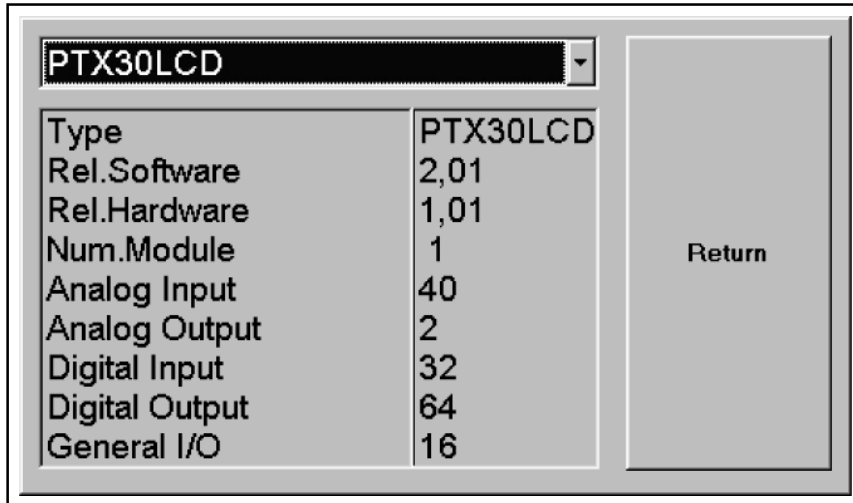

- “Phone” button:



The "Phone" button enables to open the window showing the set-up of the telephone numbers saved in the memory of the SCM.

N.B. This option is only valid if the SCM is connected to an analogical modem.

- “Help” button:



The "Help" button enables to open the online guide.

- “Exit” button:



The "Exit" button enables to exit the program.

3) **The buttons to select measurements:**

- “Measure” button:



The "Measure" button enables to visualize the inputs, either balanced analogical or analogical/digital, in the "Measurement window "(4).

- Il tasto “I/O”:



The "I/O" button, enables to visualize the outputs of the "Measurement window "(4).





- “General” button:

The "General" button, enables to visualize the general measurements of the "Measurement window "(4).

4) The measurements window:

Measurement type	Measurement name	Received value
Type	Measures	Measure
In 5	RDS	0 %
In 2	Modulazione	5 KHz
In 6	Variacap Voltage	8,45 V
In 7	Negative Voltage	-11,38 V
In 8	LCD Inverter	0,00 V
In 9	Internal 15V	15,25 V
In 10	CPU Voltage 5V	5,06 V
In 13	Pa Voltage	5,62 V
In 14	PA Current	0,08 A
In 17	Dirver Voltage	2,64 V
In 18	Driver Current	0,13 A
In 19	Temperature	25,43 °C
InD 24	External Interlock	RF On
Out 0	% Power Out	0,4 %

- The "Type" column indicates the type of measurement:

“In” -> analogical input,

“InD” -> digital input,

“Out” -> output.

When you click on any of the measurements, the window of the measurements set-up is displayed (obviously only for "I/O" and "General" measurement types enabled).

To enter a new value, it is necessary to write it in the "Data" box and press enter.

**Measure Setting**

<i>Type</i>	<i>Name</i>	
Out 0	% Power Out	
<i>Data</i>		<i>Unit</i>
10,0 %		%

Return

5) **The control bar:**

The control bar is composed of 3 parts:

- The control icons:



The password: The first icon represents the password. If this icon is activated in the station a closed lock appears on a yellow background, otherwise it is open as shown on the picture.

When you click on the icon, the window for the password selection is displayed.

The measurement cycle lock: The second icon indicates the status of the interrogation cycle of the modules. When clicking on the icon you obtain a lock of the selected module in the window displaying the summary information concerning the station (1):

It is used when it is necessary to update only a few measurements faster.

When the icon is selected, its background is coloured in red.

The bell: The third icon enables to launch the acoustic indicator in case an alarm is received.

The programation of a station: When the third icon is selected, the remote programation window is displayed in the preset stations.

When the station is preset, it is not necessary to program the data on the SIM card of the GSM modem since they are saved in the unit itself.

Please read Chapter 5: "Programation of the remote station" to know more about this function.

When you select the fifth icon, time and date are displayed.

- The recorder:

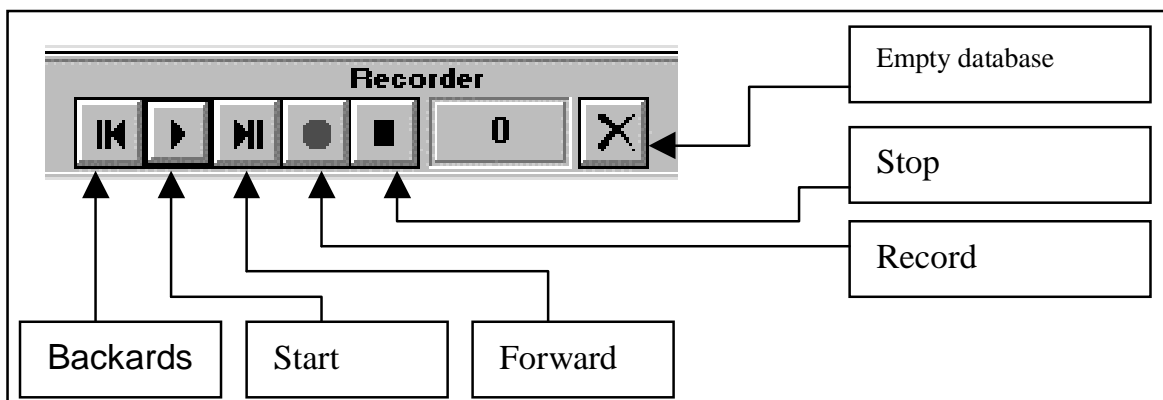

It enables to record in a database all the data received from the station.

Its functioning is similar to this of a normal tape-recorder.

- The communication status icons:

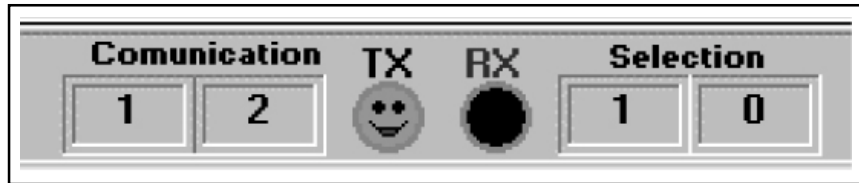

They enable to analyze the status of the serial communication.

On the left, under the word "Communication", the nod number and the identification number of the interrogated module are displayed.

In the middle, there are two icons that indicate the status of the transmission and serial reception (green=OK, red=No).

On the right, under the word "Selection" the selected node and the module are displayed in the window displaying the summary information concerning the station (1).

## 1.5 Programation of a remote station



By clicking on this icon the window showing the programation of the remote station is displayed.

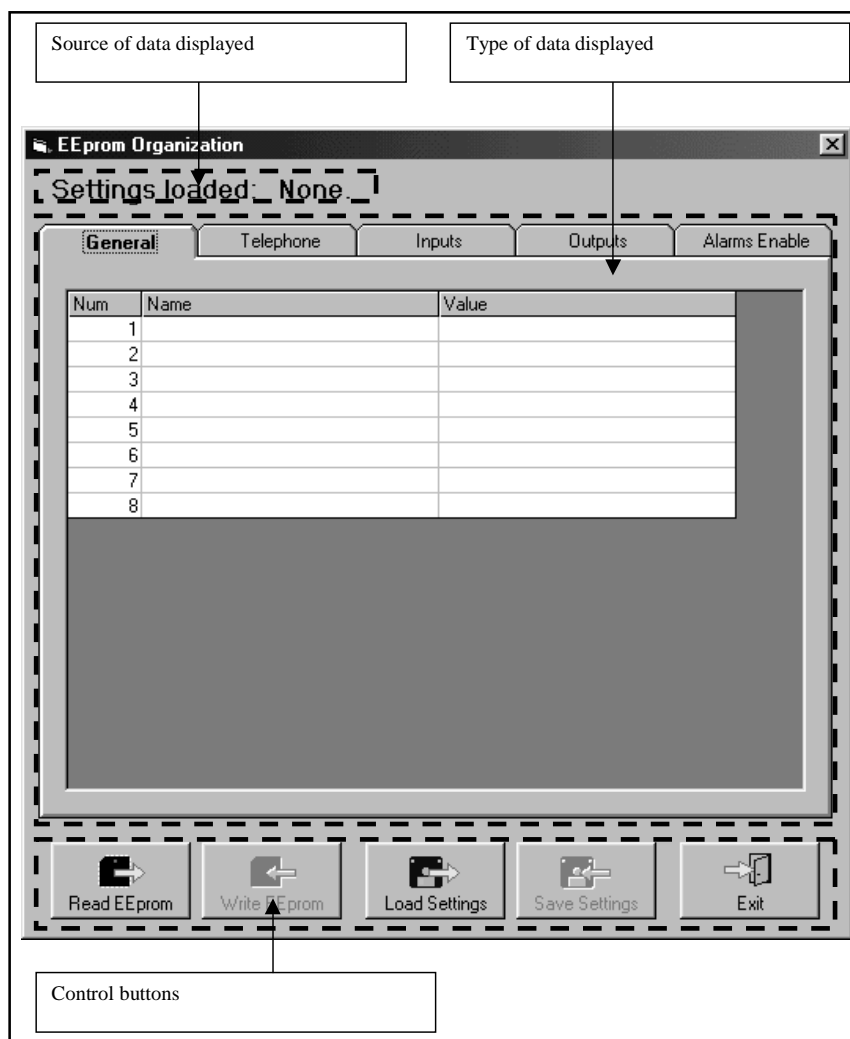

From this window it is possible:

- To read and write the parameters of the remote station,
- Enter and save the parameters in the database of the station itself.

When the window is displayed it does not contain any data, it is necessary to read them from the remote station or from the database.

### 1.5.1 How to select functions



Press this button in order to read the parameters of the station.



Press this button in order to program the parameters in the station.



Press this button in order to read the parameters from the database of the station.



Press this button in order to write the parameters in the database of the station.

In this way, each station memorized in the Telecon software contains the programmed parameters.

The type of data identify the groups of options that can be programmed:

- 1) General: these are the parameters common to all the types of RVR stations.
  - ID of the station
  - Name of the station
  - Number of the SMS Assistance Center
  - Number of SMS attempts
- 2) Telephone:
  - Phone numbers recognized by the station
  - Enables to send SMS messages to the system
  - Enables the reception of SMS messages.
- 3) Inputs: monitoring of the auxiliary inputs that generate alarms (in the predisposed systems).
  - Name of the alarm (that is transmitted in the message)
  - Intervention threshold of the alarm in percentage (0% = 0VDC, 100% = 5VDC)
  - Alarm activation front (indicates whether the alarm is activated or not in case of supply failure).
- 4) Outputs: monitoring of the outputs (in the predisposed systems)
  - Type of output commutation (status, impulsive ON or impulsive OFF).
- 5) Alarms Enable: (in the preset systems)
  - Enables the standard alarms of the station.

When you click on the parameter that you intend to modify, the data entering window is displayed.

The window is slightly different in function of the type of measurement that is to be modified.

Window for the entering of names and numbers. It is possible to write whatever.

Window for the entering of data. It is necessary to choose between the proposed options.

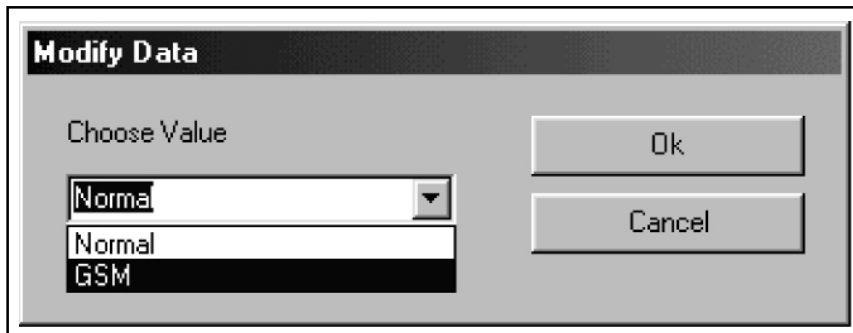

### 1.6 Structure of the stations.

The Telecon software works exclusively with databases.

Each station present in the Telecon, is composed of several blocks called Modules.

Inside the program folder, there are four folders called: Default, Module, Phbook and Stations, which contain the database of the stations.

Structure of the stations:

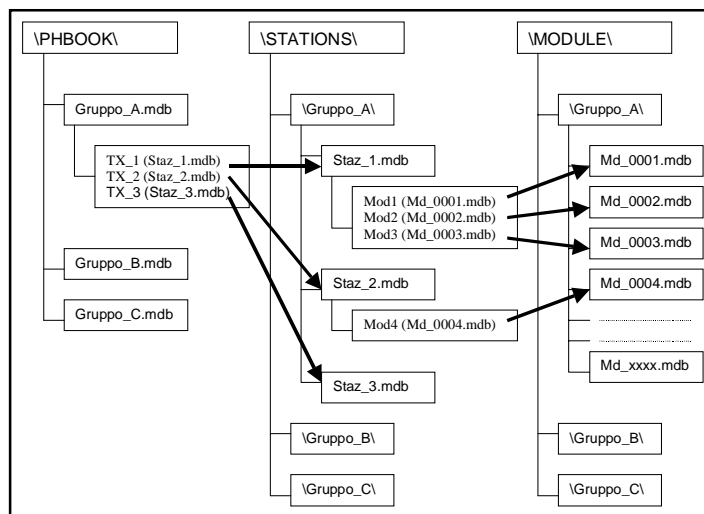

When the program is started the database used situated in the folder \PHBOOK\ is shown, ex. "Group\_A.mdb". Each group represents a series of stations.

The database situated in the folder \PHBOOK\ contain the general information concerning the stations: telephone number, connection Baud Rate, COM port used, etc.

Each station included in a "Group\_A.mdb" has a connection to a database situated in the folder \STATIONS\Group\_A\, which contains the names of the database of the modules that compose it. Such databases are situated in the folder \MODULE\Group\_A\ and are copied and renamed when the creation of the station from the folder \DEFAULT\ happens.

Example: Let's imagine a group called "Radio1", which contains one station only called "TX500".

The record of the database "Radio1.mdb" will be composed in the following way:

D	Name	Descriptions	Phone	ModemString	DialString	DBName	Com	Baud	Type	InitString	Protocol
1	TX500	-- None --	01239	ATX3	ATDT	TX500.MDB	1	4	0	9600,n,8,1	PROTOCOL_RVR

The area "DBName" contains the name of the database (TX500.mdb) situated in the folder \STATIONS\Radio1\ which contains the information concerning the composition of the station.

The database of the station, is composed by five tables:

- Alarm

Contains the data concerning the received alarms.

- Alarm\_Storic

Not exploited.

- Configuration

Contains the data concerning the composition of the station.

- Measure\_Storic

Not exploited.

- Personal\_Window

Contains data concerning the personalization window.

Therefore in the "Configuration" table of the database \STATIONS\Radio1\TX500.mdb you will find information concerning the composition of the station.

Structure of the "Configuration" table.

Node	Module	Name	DBName	Module Number	Enabled	Type	Configuration
0	0	Total Node		1	0		
1	0	TLCLCD	MD_0001	3	-1	TLCLCD	>_ _
1	1	PTX30LCD	MD_0002	0	-1	PTX30LCD	>_ _e_
1	2	TLM PJ500	MD_0003	0	-1	TLM2	>_ _._

The area "DBName" contains the name of the databases situated in the \MODULE\Radio1\ folder which contain the information concerning the modules.

## 1.7 Structure of the database

The TLC300 has one (or two) telemetry cards (8 balanced analogical inputs, 16 analogical/digital inputs and 8 relay outputs) and one I2C.

When seen through the Telecon, each telemetry card present and each unit connected through I2C appear as Modules

There are some acknowledgements to respect:

- 1) The first Module (number 0) ALWAYS contains the unit which is equipped with telemetry.
- 2) Then the units connected through I2C Bus are shown.
- 3) Then the telemetry cards

Let's analyze an example of typical station: TX500 equipped with telemetry (TLC300/T1).

The TX500 is composed of: one PTX30LCD, one PJ500MC and obviously the TLC300.

The station, for the Telecon, will be composed of:

- 0 - TLC300
- 1 - PTX30LCD
- 2 - Telemetry card for PJ500MC

### 1.7.1 The modules

Each Module has a corresponding database which contains the data concerning the available measurements.

The database, contains seven tables:

- Alarm Name  
contains the information concerning the alarms
- Analog Input



contains the data concerning the analogical inputs

- Analog Output

contains the data concerning the analogical outputs

- Digital Input

contains the data concerning the digital inputs

- Digital Output

contains the data concerning the digital outputs

- General

contains the data concerning the general measurements

- Info

contains the information concerning module

N.B. In function of the type of unit that they represent, the tables can also contain data.

Let's Analyze the module related to the standard telemetry card: it contains: 24 analogical inputs (8+16) and 8 relay outputs; therefore data will be found only in the Analog Input and Digital Output tables.

Similarly, for the PTXLCD (which has 39 analogical inputs, 2 analogical outputs, 8 digital inputs, 29 digital outputs, 8 general measurements), data will be found in all the tables.

All the tables (except Info and Alarm Name) have the same structure:

Name of area	Type of data	Description
Key	Numerical	Univocal identification key
ID Measure	Numerical	Identification of the measurement
Display Order	Numerical	Ordering displayed data
Enable Input	Yes/No	Enable input
Enable Display	Yes/No	Enable display
Name	Text	Measurement Name
Measure Unit	Text	Measurement Unit
Conversion Type	Text	Type of conversion
End Scale	Numerical	End scale
Start Scale	Numerical	Start scale
Max	Numerical	Maximum value
Nominal	Numerical	Nominal value
Min	Numerical	Minimum value (offset)
Format	Text	Displaying Format
Input Mask	Text	Input Mask
Resolution ADC	Numerical	Resolution ADC converter
Type	Numerical	Type of measurement
Text for Max	Text	Text to be displayed when maximum value is reached
Text for Min	Text	Text to be displayed when minimum value is reached

For example:

The first analogical input of the telemetry card is composed in the following way:

Key	0	Number of the measurement
ID Measure	0	Position in the order display
Display Order	1	It is possible to enter values (not for the inputs)

Enable Input	Si	It is displayed on the Telecon grids
Enable Display	Si	Name of the measurement
Name	Analogical 1	Name of the measurement
Measure Unit	V	Measure unit, Volt
Conversion Type	TENS/CORR	Conversion for voltage and current measurements
End Scale	5	Value displayed when input at the maximum
Start Scale	0	Value displayed when input at the minimum
Max	6	Value after which the alarm is generated
Nominal	0	Not used parameter
Min	0	Value under which alarm is generated
Format	#0.0	the datum has a number after the comma
Input Mask	###	Not used parameter
Resolution ADC	1024	ADC resolution (useful for calculations)
Type	1	1 = analogical input
Text for Max	???	Text displayed when at the maximum (only digital input)
Text for Min	???	Text displayed when at the minimum (only digital input)

With such settings, the voltage present at the input will be displayed.

### 1.7.2 How to modify the database

If the user needs to modify the measurements on already existing databases, the parameters to modify are the following:

- Conversion Type
- End Scale
- Max
- Enable Input
- Enable Display

Conversion Type: determines the calculations to make with the received datum.

The different algorithms were created in function of the requirements of the equipment manufactured by R.V.R. and include power measurements, voltage and current, logical status, etc.

End Scale: indicates the maximum value displayed corresponding to the maximum voltage applied at the input.

Max: value indicating the threshold for the generation of a visible alarm on the Telecon grids.

Enable Input: value Yes/No which indicates whether it is possible to set a measurement value.

Ex. When an input is selected it is on "No" because it is not possible to set an input value, while for measurements like i.e. the output power of the PTXLCD, it is on "Yes" because the user can choose the value he wants to enter.

Enable Display: value Yes/No which indicates whether the measurement appears in the Telecon grids has also a consequence in the personalization.

## 1.8 Creation of groups and stations

In this chapter we will deal both with the creation of a station and with the creation of a group.

### 1.8.1 How to create a group

From the main window, select the button "New".

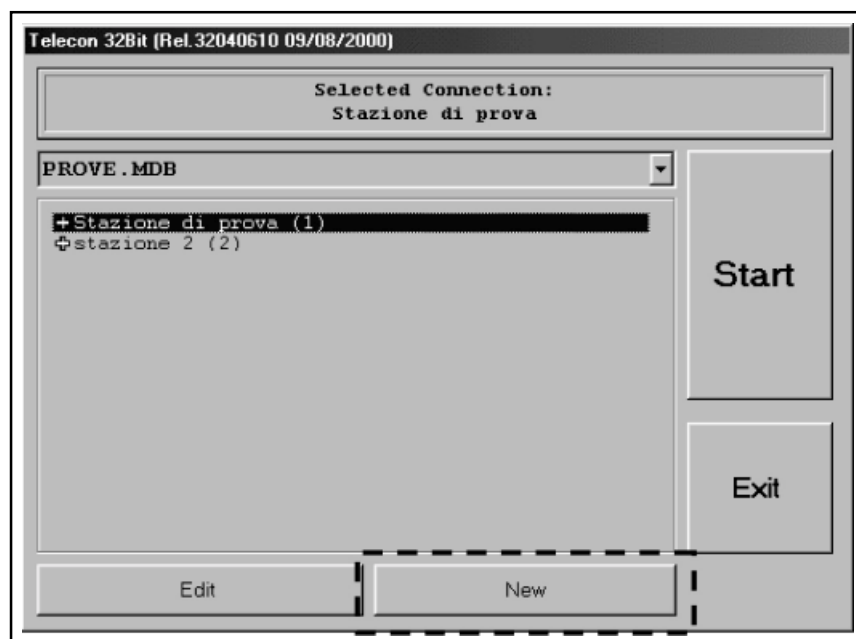

The program will ask you if you want to copy the list of stations which are part of the selected group and then it will ask the name of the new group.

At the end of the creation process, you will obtain a new group with a station called

"Default" in case you have chosen not to copy the list of stations, otherwise you will find the same list of stations that composed the original group.

### 1.8.2 How to create a station

From the main window, select the "Edit" button.

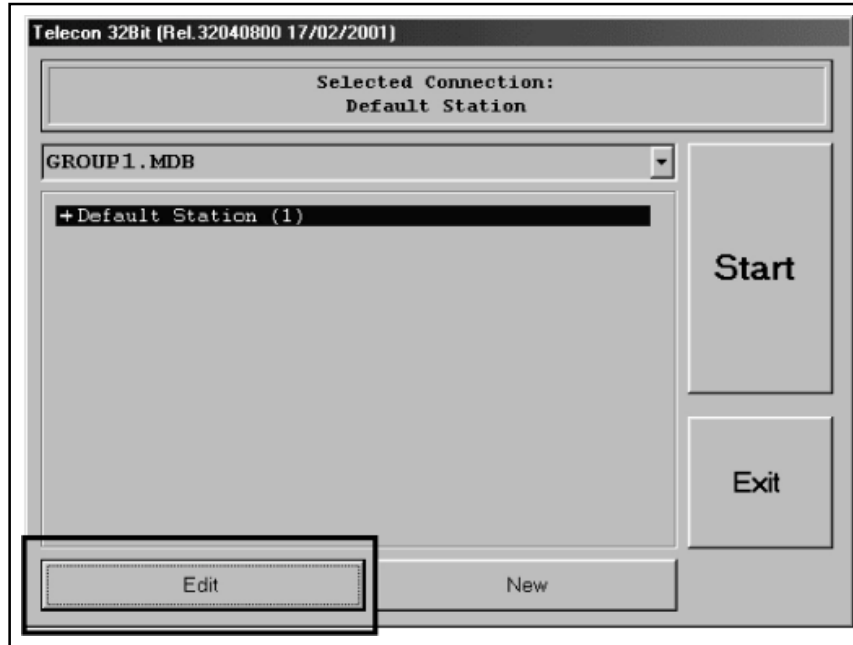

The editing window of the station will be displayed. It is important to mention that the stations are composed of two parts, one is situated in the "Phone book" window where the connection is monitored while another is situated in the structure of the station.

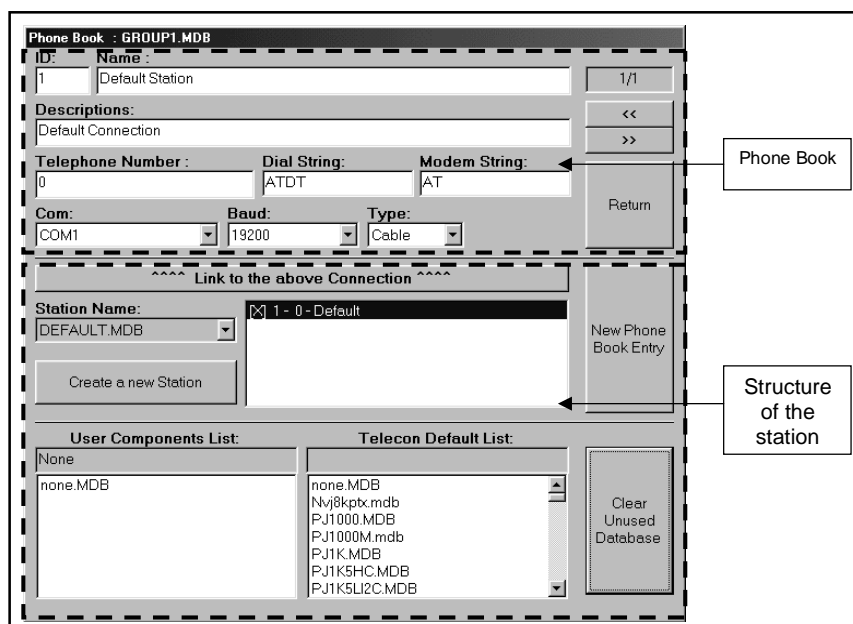

Structure of the station:

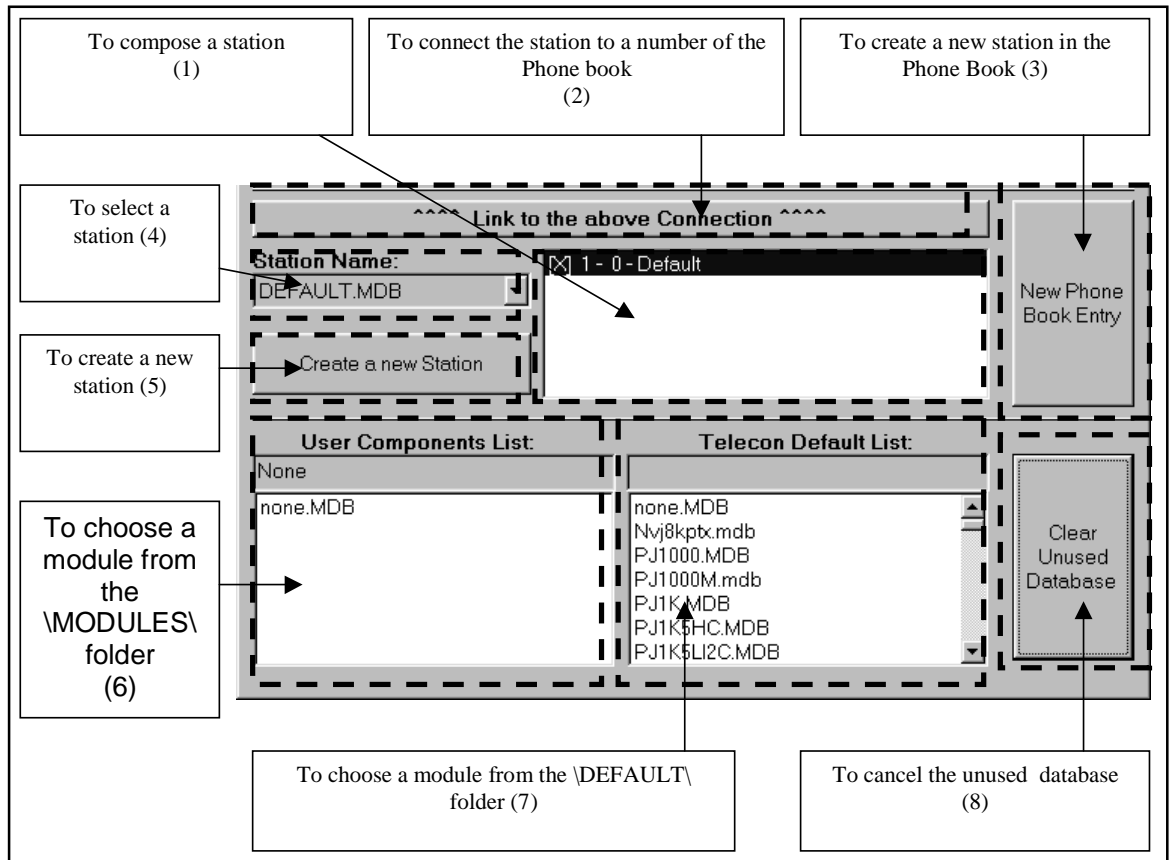

The steps for the creation of a station are the following:

The chosen station is TX500 with telemetry.

As already mentioned in Chapter 7, the station will be composed of three modules,

- 0 - TLC300
- 1 - PTX30LCD
- 2 - Telemetry of the PJ500MC

It is necessary to create a new name in the Phone Book, which can be done by selecting button (3).

- 1) Select button (5): the program will ask you whether you want to copy the station that is currently select, press "no"; enter the name of the new station ( Ex.TX500 ).
- 2) Select the new created station from the menu (4).
- 3) In the window "Station composition " (1), you will find:

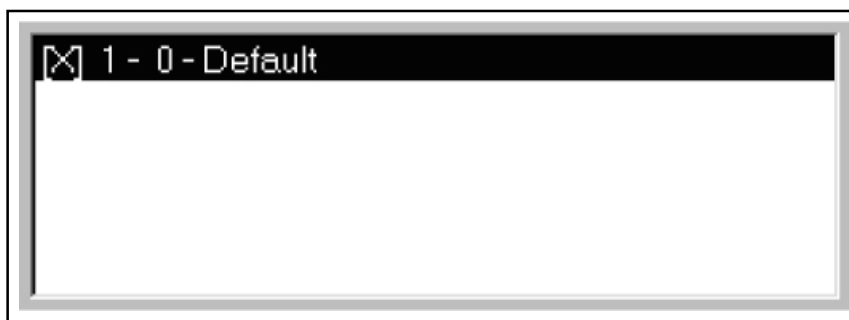

- 4) Search the module "TLC300.mdb" in the list (7)
- 5) Click on the module and keep the left button of your mouse pressed, and drag it into the window (1).

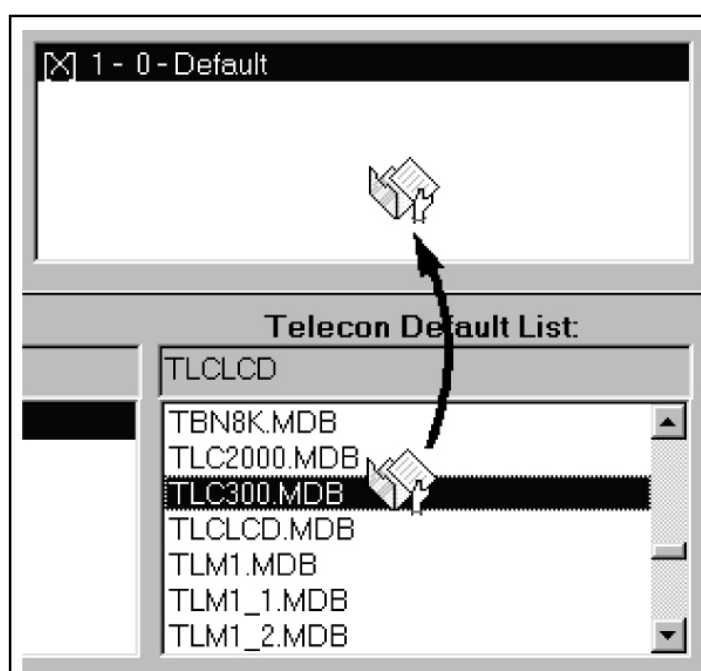

- 6) The program will ask you whether you want to replace the selected module (Default) by the module you have chosen. Select "Yes".

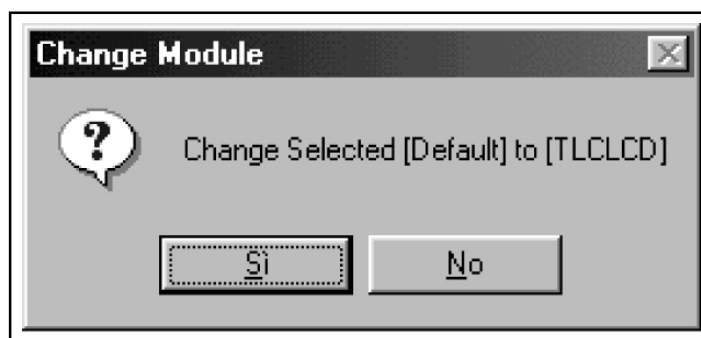

In this way you will replace the "Default" module by "TLCLCD", which are the letters identifying of the TLC300.

- 7) In the window (6) "Md\_00001.mdb" is displayed, which is the "TLC300.mdb" database renamed and copied in the folder \MODULE\Group1\.
- 8) Search the module "PTX30LCD.mdb" in the list (7).
- 9) Click on the module and keep the left button of your mouse pressed, and drag it into the window (1)

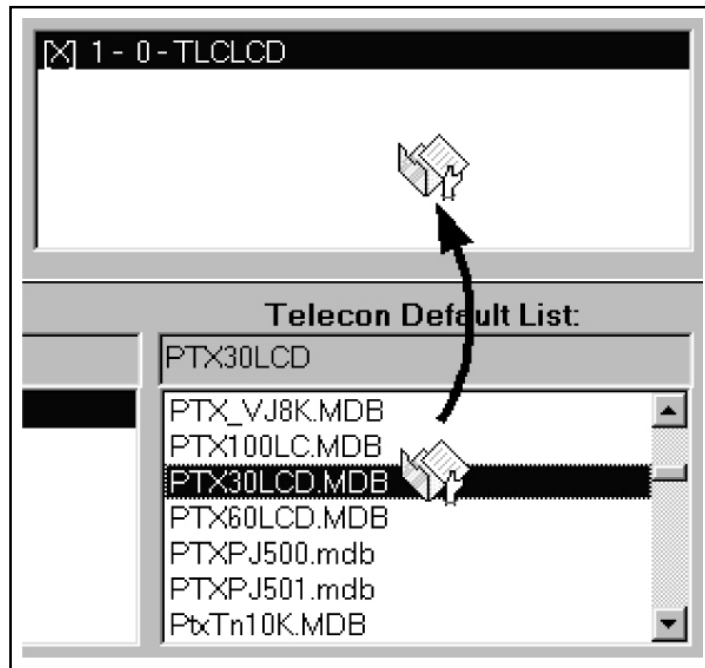

- 10) The program will ask you whether you want to replace the selected module (TLCLCD) by the module you have chosen. Select "No".

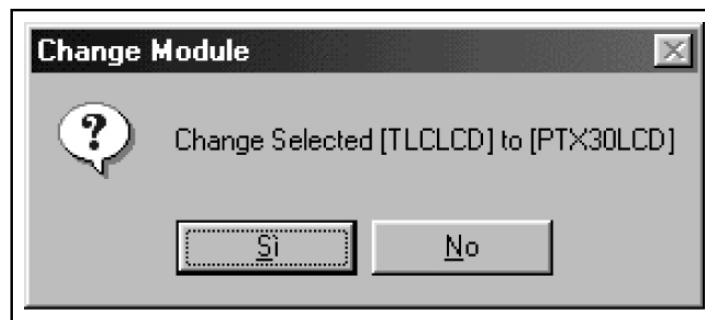

The program will ask you whether you want to add (append) the module to the configuration of the station. Select "Yes". If you choose "No" the module will not be added to the station. The program will ask you to confirm the node and module numbers, the program automatically chooses the values so they should not be changed.



In the window (6) "Md\_00002.mdb" is displayed, which is the "PTX30LCD.mdb" database renamed and copied in the \MODULE\Group1\ folder.

- 11) Search the module "PJ500.mdb" in the list (7).
- 12) Repeat 8 and 9. You should obtain the situation shown in Figure:

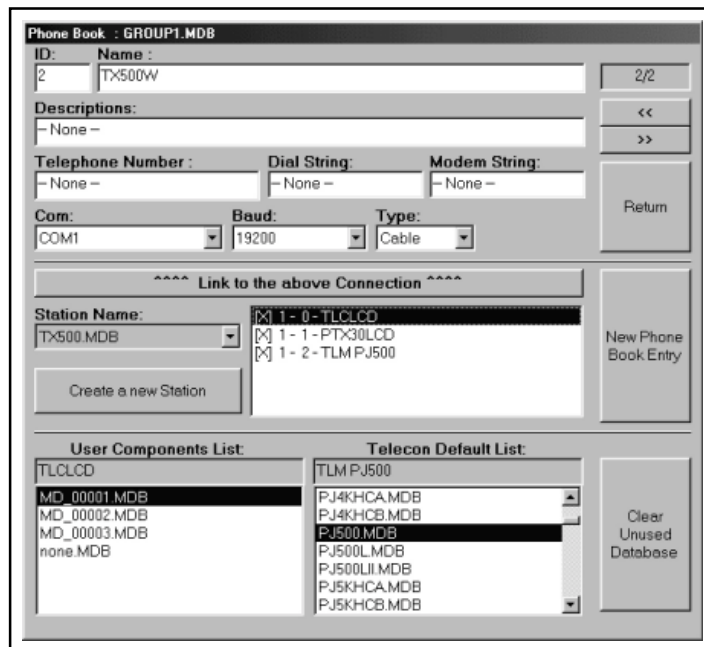

- 13) The structure of the station is completed, so it is now necessary to connect it to a number from the Phone book. In order to do so, press button (2).

The guided creation of a station is completed.

## 1.9 Creation and editing of the Personalization window

### 1.9.1 Preliminary acknowledgements

In this chapter we will analyze the creation of a personalization, starting from an empty window.

Press the "Detail" button to enter the Personalization window







Click on button "F4" situated on the window to enter the "edit" mode, the shape of the mouse cursor will change  .

Click with the right button of your mouse to enter the menu with three options:

- Add Control.

To add a control

- View Grid.

To switch on or off the display of the grid

- Save Window.

To save the personalization window.

N.B. We advise you to use this function very often in order to avoid losing the realized work

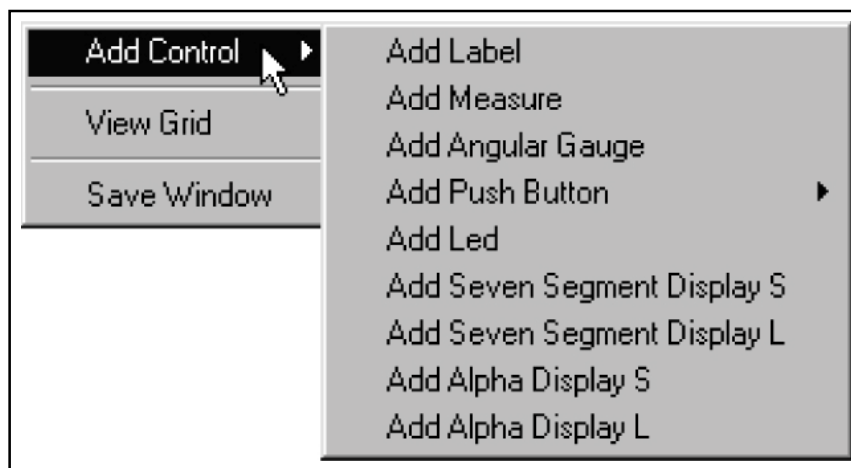

The "Add Control" menu contains the submenus from where you can choose the items that can be added in the window:

- Add Label.

Frequency

To add a label.

- Add Measure.

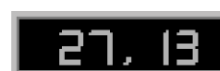

To add a numerical measurement (the use of the "Alpha Display") control is anyway advised

- Add Angular Gauge.

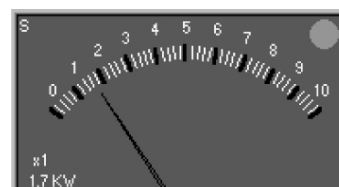

To add an analogical instrument.

- Add Pushbutton.

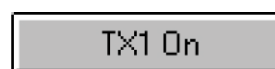

To add a button in order to send commands.

- Add Led.



To add a signalisation led.

- Add Seven Segment Display (S o L).



To add a LCD type display for numerical measurements

- Add Alpha Display (S o L).



To add an alphanumeric display, which may be used

### 1.9.2 Guided creation of a personalization

In this brief instruction chapter, we will explain the operations which are necessary in order to create a personalization window.

La station used as a reference will be a TX500 (TLC300, PTXLCD, PJ500MC)

In order to add an instrument to indicate the output forward power.

- 1) Press F4 in order to enable the EDIT mode
- 2) Click with the right button of your mouse on the area where you want to add the command.
- 3) Select "Add Angular Gauge" from the "Add Control" menu
- 4) The selection window will be displayed

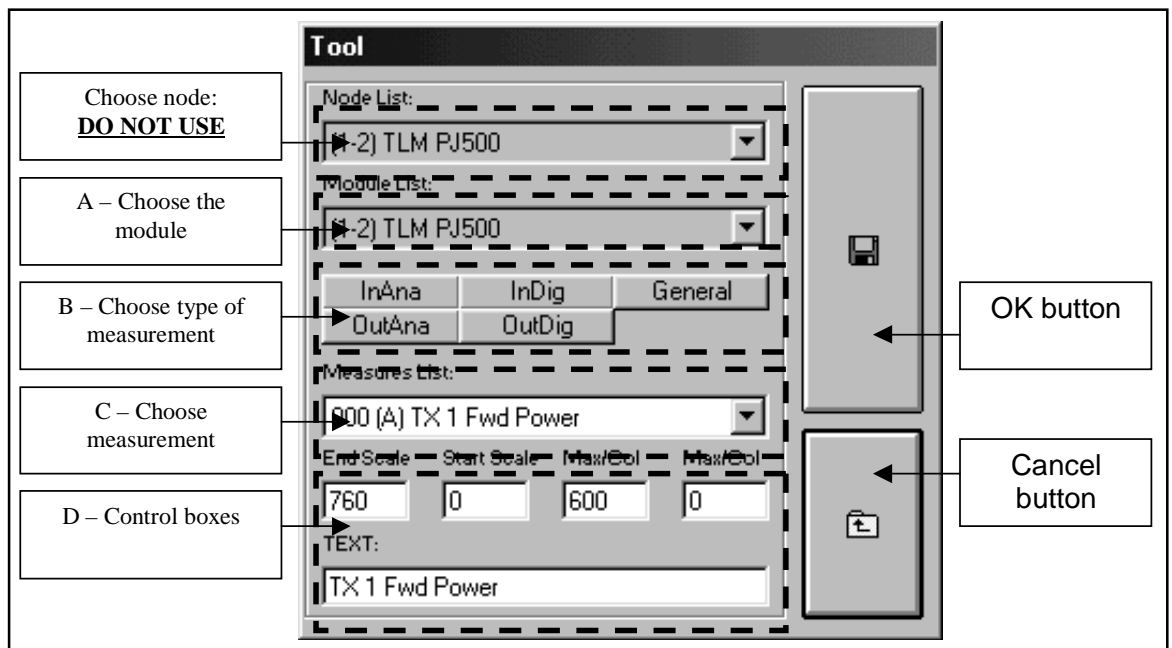

In the box "A" choose the module "1-2" which corresponds to the PJ500.

- 5) Choose between the "B" buttons, on "InAna" in order to have the list of analogical measurements displayed.
- 6) In the "C" box select the "Fwd Power" measurement.  
 "000 (A) TX1 Fwd Power" means: "000" which is the input number, "(A)" indicates that the input is analogical, the remaining is the name of the input (which is the same as box "Text:" from the group "D").
- 7) These options are valid only for the "Angular Gauge" control: boxes from group "D".

If you wish to replace the end scale of the analogical meter, write the required value in the "End scale" box.

If you require a maximum value inside the scale (in order to have an alarm led on the command, when the value is superior), write it in the "Max/Col" box.

Ex: If you enter 760 as an "End scale" value and 600 as a "Max/Col" value, you will have a command as shown in the figure. Please note that when the value setted in "Max/Col" is exceeded, the green led situated on the upper and right side becomes red.

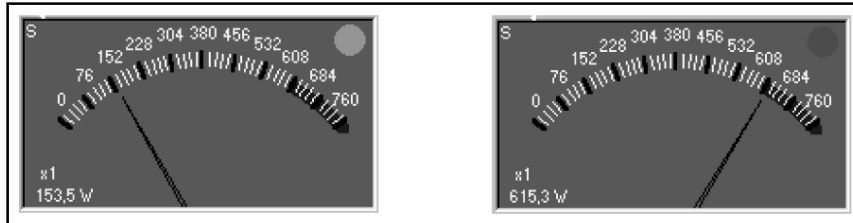

8) Press the "OK" button.

The new command was positioned. It is now possible to have it moved, redimensioned or cancelled.

Please note that when the mouse cursor passes on the control, the icon  changes. In order to move, cancel or vary the dimensions or change the parameters of the command, press the right button of your mouse. The menu from which it is possible to make choices will be displayed.

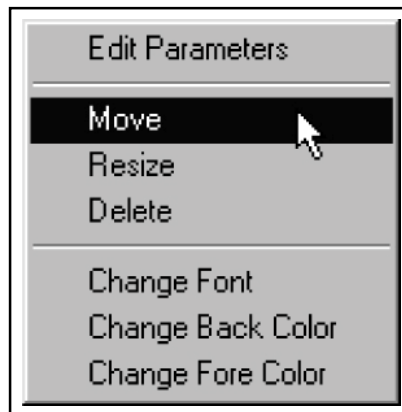

"Change Font" "Change Back color" and "Change Fore Color", are used for the labels (label).

To insert a label (label) in order to recognize the measurement.

- 1) Choose "Add Label" from the "Add control" menu.
- 2) Select the same measurement chosen formerly: PJ500 FWD Power.
- 3) 3. Press the "Ok button".

The result will be as follows:

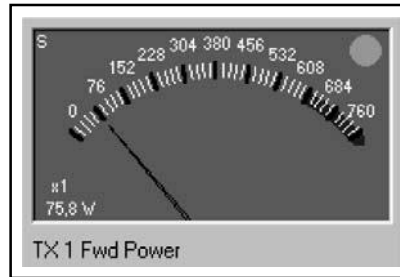

How to insert a led to indicate the presence of an SWR alarm.

- 1) From the menu "Add Control" select "Add Led".
- 2) 2. Select the module PJ500 in box "A".
- 3) 3. Among the "B" buttons, click on "InAna".
- 4) In box "C" choose the measurement "011 (D) TX1 SWR". Make sure the type of input selected is (D) which means it is digital.

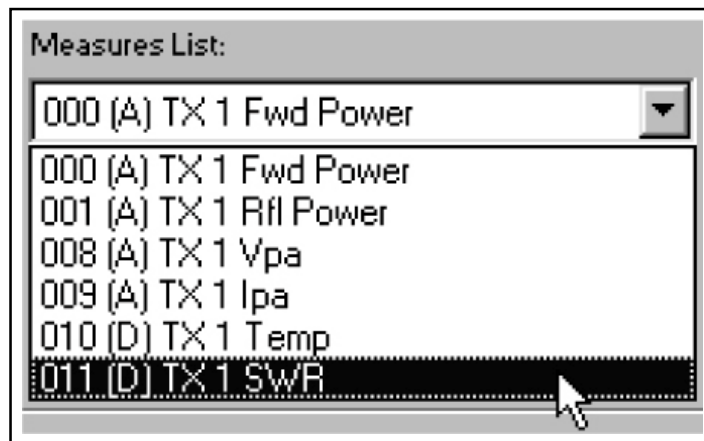

5) It is now possible to select the colour of the led in function of the status of the input:

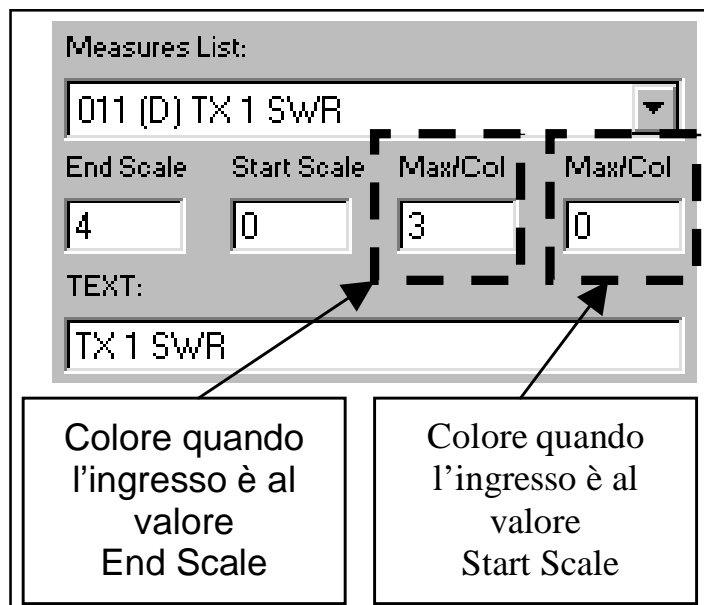

The available colours are five:

- 0 - Black.
  - 1 - Red.
  - 2 - Yellow.
  - 3 - Green.
  - 4 - Blue.
- 6) Press the "Ok" button.
  - 7) If necessary, position the led in the place required.
  - 8) Repeat the same procedure in order to insert a label with the name of the alarm.

We will now create two buttons to switch on and off the transmitter.

- 1) In the "Add Control" menu select "Add Pushbutton "On Type".
- 2) Scegliere il modulo PJ500 dalla casella "A"
- 3) Among "B" buttons select "OutDig".
- 4) In box "C" select the measurement "000 (>) TX1 On".
- 5) In the "Text:" box, enter the name that will be displayed on the button.

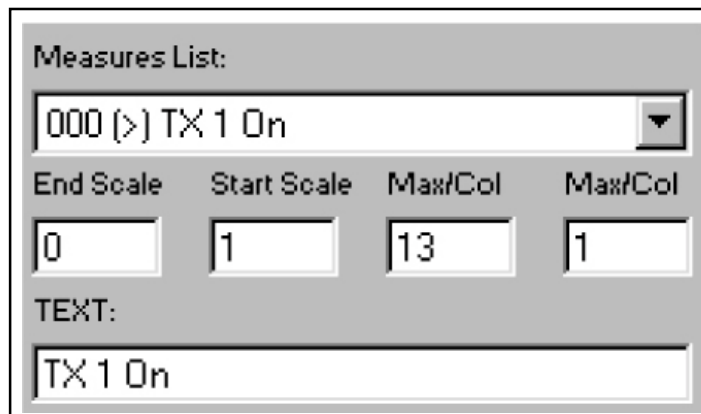

Measures List:			
000 (>) TX 1 On			
End Scale	Start Scale	Max/Col	Max/Col
0	1	13	1
TEXT:			
TX 1 On			

- 6) Press the "Ok" button.
- 7) If necessary, re-position or change the dimensions of the button.
- 8) In the "Add Control" menu select "Add Push button "Off Type"
- 9) Among "B" buttons select "OutDig".
- 10) In the box "C" select the measurement "001 (>) TX1 Off
- 11) In the "Text:" box, enter the name that will be displayed on the button.
- 12) Press the "Ok" button.
- 13) If necessary re-position or change the dimension of the button.

The personalization should be as follows:

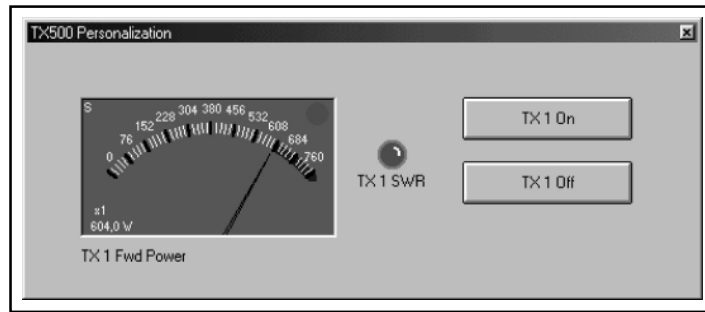

Now you just have to save the window by clicking on the right button of your mouse and choosing "Save Window".

*This page was intentionally left blank*



## 2. Monitoring Telemetry Stations

### 2.1 Functioning

This is a telemetry software that gives the possibility to call automatically and cyclically every station from a list of stations, having their status displayed in a very simple and clear way and indicating which station is in alarm and the type of alarm.

Moreover, it is possible to have the software calling a station after having been informed by an SMS, and have its status displayed immediately.

### 2.2 Installation

- Insert the CD-ROM in the CD-ROM player.
- From the desktop, open "Program Manager".
- Double click on the CD-ROM player to visualize its content.
- Double click on the program Tlc32bit.exe in order to set up the installation.

It may be required to install the drivers which are necessary for the access to data, before installing the software.

- When the installation is completed, the "Tlc32bit" group which contains the programs: "Telecon 32bit" and "GSM Init" will be created, after which the connection icons will appear on the Desktop.

#### **Required systems:**

- Operational system:  
Windows 95 ®, Windows 98 ® either first or second edition, Windows ME ®.  
The software does not work under Windows NT ® and Windows 2000 ®.
- Processor:  
Intel Pentium ® 75 MHz or better.
- Minimum Memory required:  
32MB Ram.
- Minimum capacity on Hard Disk required:  
Minimo 50Mb.

### 2.3 Telemetry software

As you can see on the image, the telemetry software is composed of three main windows:

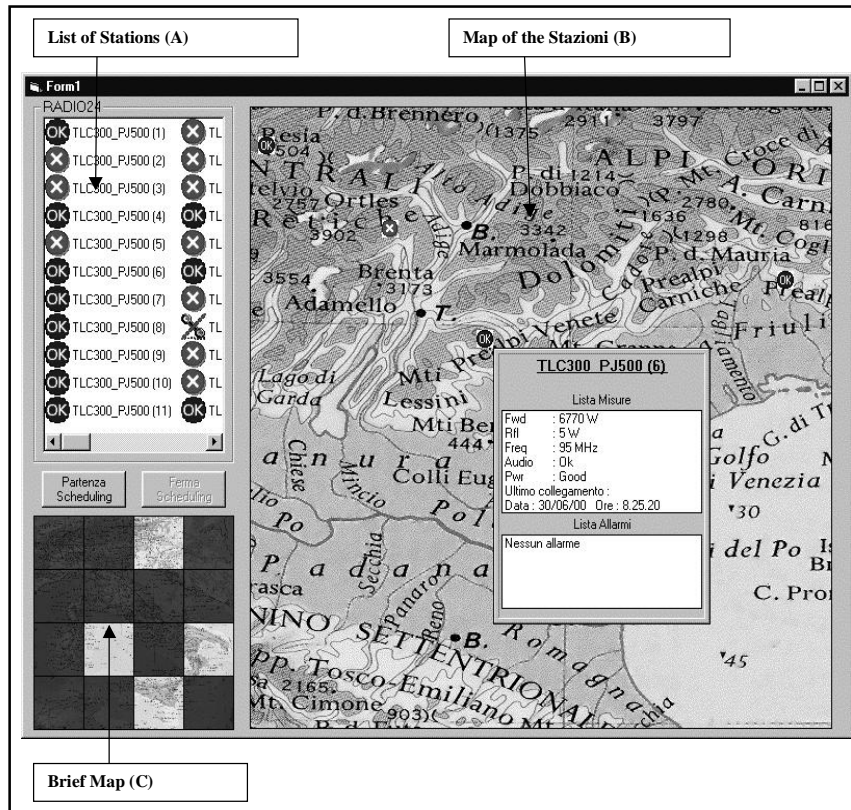

### 2.3.1 List of Stations (A).

In this list all the stations that concern a customer are displayed.

They are sorted in the following way: presence on the map, priority, frequency of calls and station number in the database.

When positioning your mouse on a station, it is automatically centered in the map (B), and the station will start flashing.

### 2.3.2 Map of the stations (B).

The position of the stations and their status are displayed. Such map must be built by the user simply by dragging the required stations (taken from the list of stations (A)) to their locations on the map. Once the station is positioned, the schedule monitoring window is displayed. The station will have a different icon in function of the alarms status.

When positioning the cursor on one of these icons a window displays the last parameters and alarms registered, if received.



When clicking with the right button of your mouse on the icon indicated above, a cascade menu will display the following functions:

When selecting " Call Station " the immediate call will be made and the consequent data will be updated.



When selecting "Reset Station" you can make an attempt to reset the functioning conditions in case of alarm.



When choosing "Telecon" you can call the station with the normal telemetry software in order to get more detailed information (for expert users).



When choosing " Properties" a sub-menu with 2 possible choices is displayed:

" Scheduling Manager" which displays a window for the setting of scheduling parameters and priority calls. Such priority will also be used put the stations in order in the list (A);

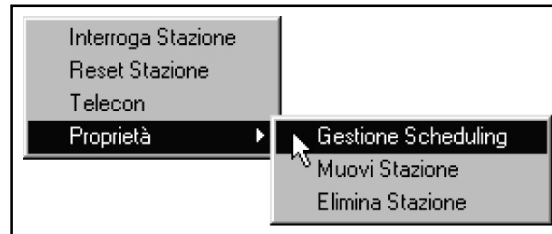

"Move Station" is used to re-position the station on the map.



"Cancel Station" is used to cancel the station from the map (but not from the database).

When moving the mouse having the left button pressed, you can scroll the geographic map.

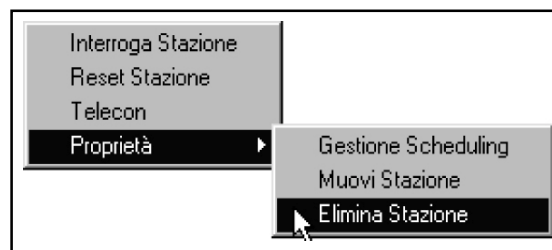

### 2.3.3 Brief Map (C).

Such map is a reference for the Stations location (B). Basically, it is the same map, but reduced and divided into 16 quadrants. Such quadrants enable a selection of only the required part of the country, since it is impossible to show the whole map in a defined way. Apart from that, in case of alarm the quadrant where the station is situated will be coloured in red to indicate an anomalous situation. In this way it is possible to keep under control the status of all the stations without needing to move the mouse.

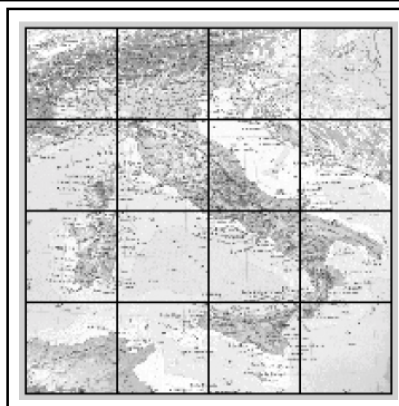

## 2.4 Scheduling functions

The Scheduling is structured in the following way:



**Gestione Scheduling**  
**TLC300\_PJ500 (1)**

Priorità:  (Min Med Max)

N° tentativi:  2  Illimitato

Inizio Scheduling:

Conferma      Annulla

- 1) The parameters that can be modified in the station are:
  - Frequency of the calls, being possible to choose among the following values:
    - 1 - 3 times a day (morning, afternoon and evening)
    - 2 - once a day, morning
    - 3 - once a day, afternoon
    - 4 - once a day, evening
    - 5 - 3 times a week
    - 6 - once a week
    - 6 - once a month
    - 8 - Never





- Priority. The priority will be selected through a slider having three positions (high, medium, low) that the customer may use to set the order in which calls should be made. Basically, if some stations are more important than others, it will be necessary to assign to this station a priority higher than the priority of other stations. When the system starts making the calls, it will first call the higher priority stations, then medium and so on... This choice in priorities also influences the order in which the stations are displayed in the List (A).
- Number of attempts. It is possible to set a number of attempts "retry" from 1 to 99 + ∞ which represent the number of attempts that the program must make before the station is considered as disconnected, therefore before communication alarms are released. If you choose ∞ the software will try to make the connection until he succeeds to.

All the other call parameters, telephone number etc., are copied from the Telecon database.



The stations are put in order in the list (A) for:

- Presence on the map,
  - priority
  - frequency of calls,
  - identification number in the Telecon database
- 2) The two buttons: "Start Scheduling" and "Stop Scheduling" are used to start or to interrupt the automatic procedure of calls. In this way if the user wants to call a station manually (while the cycle is started), he will have to set the software on "Stop Scheduling", then wait that the actual call is completed (if there is a call being made) and therefore he will be able to make the call by selecting the proper icon with the mouse on the cascade menu. It would be appropriate to insert a password for the selection from automatic to manual mode so that only the specialized technician has access to such operation. Anyway the software should always start in Automatic mode.
  - 3) In automatic mode the software starts from the first station of the List (A), and so on until the last one (N.B. ONLY the stations that are present on the map are called). Once the list is finished, and in function of the number of retries setted, the system calls the stations that did not respond the first time. The software will go on until a response from all the stations is obtained and until there are no retries available.  
  
In case the call cycle is completed before the change of call cycle, the program remains in stand-by; the "Start Scheduling" button changes to "Call Stations".  
  
In this way it is possible to have the program making an additional cycle of calls to all the stations without taking into account the last call and without exiting the scheduling cycle.
  - 4) The following 4 symbols indicate the status of the stations:

Where these icons appear:

-  indicates that the station is working correctly.
-  indicates that the station is in alarm.
-  indicates that the maximum number of retries was reached.
-  indicates that the program is making a retry.

There are also three other symbols used in the list (A):

-  indicates that the station is being called (used only in scheduling).
-  indicates that the station has not already been called (used only in scheduling)
-  indicates that the station is not present in the map.

Apart from the normal parameters displayed (Power, frequency etc. ) there will also be the time and date of the last connection.

- 5) 5. When the scheduling cycle is operational, the following functions are not available:
- dragging of stations to the map
  - positioning of the stations from the list (A) to the map
  - - the menu selected with the right button of the mouse is not available, except the scheduling configuration window that can be seen but not modified.

## 2.5 Technical information concerning the realization

For the realization of this software we have used the telemetry software (TELECON) with an additional new window..

The basic communication structure of the software remains the same and all the functions of Telecon remain unchanged. Except this new window and the database of the customer filled with the data present in the Telecon PHBOOK directory.

In such database the user may add new areas and tables in function of the following criteria:

- A. Five new areas were added to the Phone\_Book table of the database:
- 1) Presence of the station on the map and therefore also the presence of the scheduling automatic procedure.
  - 2) Name of the table where the registered data and scheduling parameters are entered.
  - 3) Priority number of such station.



The area 3 will be used in order to define the position of a given station in the list (A) and therefore the order for the automatic calls.

4) Frequency of station calls according to the scheme:

0 - 3 times a day (morning, afternoon and evening)

1 - once a day, morning

2 - once a day, afternoon.

3 - once a day, evening.

4 - 3 times a week

5 - once a week.

6 - once a month.

7 - Never.

5) Date of the beginning of the scheduling

B. Configuration tables of the stations. Basically for each station present in the Table Phone\_Book, there will be 2 corresponding tables having a name with progressive initials that will refer to the station situated in the area formerly described. The name of the two stations will start with a different suffix in order to identify them:

"\_sto" for the table where the data received by the remote station are stored,

"\_cfg" for the table where the scheduling configuration data are registered.

The following areas are present in these tables:

Table "\_cfg"

1) Position X on the map. (Single)

2) Position Y on the map. (Single)

3) Data Start Scheduling

4) Start Time of Scheduling

5) Number of Retry from 1 to 99, with 0 indicating "unlimited"

6) Date of the last connection

7) Time of the last connection

8) Status of the station during the last connection:

0 - OK - Station functioning correctly.

1 - COM - Communication problem (when maximum number of retry is reached)

2 - RETRY - Station making a Retry.

3 - FAULT - Station in Alarm.

Table "\_sto"

1) String received with data.



- 2) String received with alarms.
- 3) Byte indicating the number of alarms present.
- 4) Date of the last connection.
- 5) Time of the last connection.
- 6) Status of the station at the last connection (see point 8)

Each station present in the Phone\_Book table will have a corresponding configuration table as shown in point B.

Each time the software will restart these data will be loaded and displayed.

*This page was intentionally left blank*

### 3. Interconnection example (TLC)

#### 3.1 In Digital with RVR's LCD Equipment

In the case of connection between the TLC system and digital equipment exclusively using the digital input on bus Ilc must respect some sagacities:

- PTX-LCD excitors serie must have always the lower addresses.
- The coupler HC-LCD serie, in order of addresses after the excitors, must have Type = 133.
- The amplifiers will follow all then.

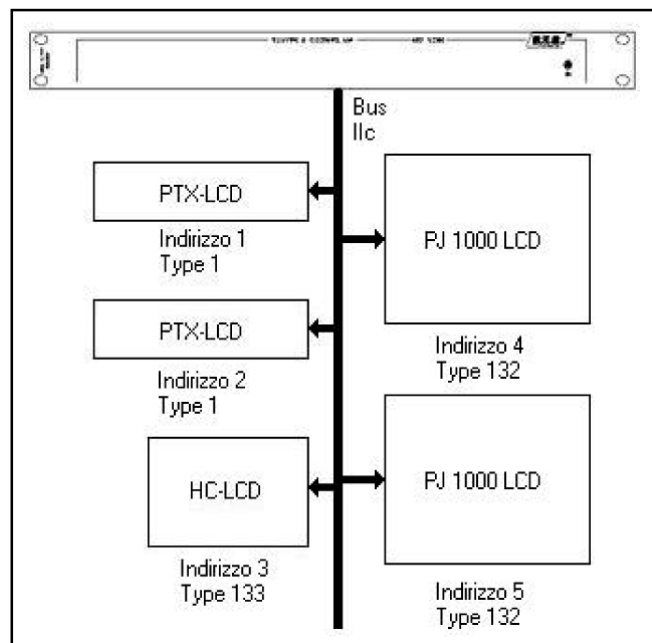

The Type that identified the digital cards are described in the following table:

Type	Nome
0	None
1	PTX30LCD
2	SCM4
3	TLC300/2000
4	SCM1
5	PTX60LCD
6	PTX100LCD
7	TLC tube
8	PTRL NV
9	RXRL NV
129	Telemetry card type 1
130	Telemetry card type 2
131	Telemetry card type 3
132	Mosfet Protection
133	Hc Primary
134	Hc Simple

### 3.2 In Analogic with RVR's LCD Equipment

To connect different RVR' base equipment between they, that aren't digital, is necessarily use an IB (see accessories), that allows the redistribution of the signals them coming from the equipment in order to make them to reach in right way on the inputs of the TLC.

All the connections between the devices come made through standard parallels cables, connecting between the IB and the equipment the outputs that have the same label:

- Service -> Service
- Telemetry -> Telemetry

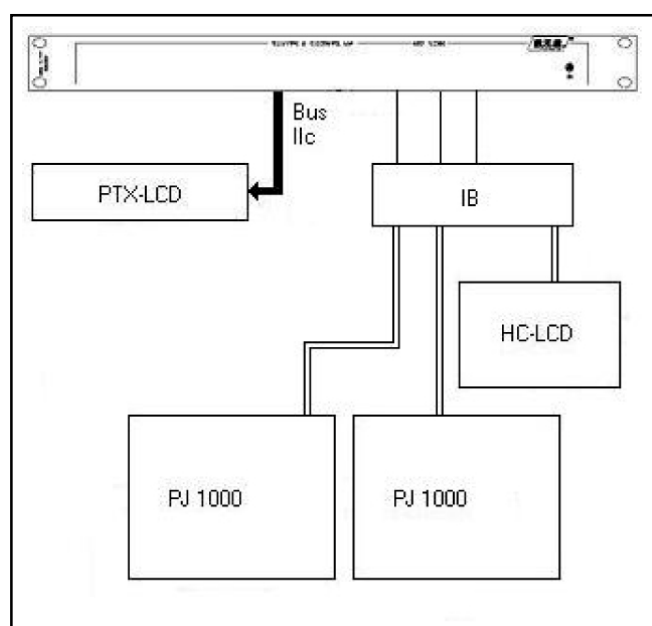

### 3.3 In Analogic with Generic Equipment

In this case it must resort to the connection tables, remembering that the balanced inputs are operative with not greater tensions of 12V while those digitals arrive to the maximum to 5V.

The tensions must be in continuum current.

### 3.3.1 How to control a D.C.voltage superior to 5V

Connect to DB25 marked as BALANCED ANALOG INPUT on the PIN described in the table

Pin number	Meant	Adj. Trimmer
2 (+), 14 (-)	Analogic balanced input n°1	RV1
3 (+), 16 (-)	Analogic balanced input n°2	RV2
5 (+), 17 (-)	Analogic balanced input n°3	RV3
6 (+), 19 (-)	Analogic balanced input n°4	RV4
8 (+), 20 (-)	Analogic balanced input n°5	RV5
9 (+), 22 (-)	Analogic balanced input n°6	RV6
11 (+), 23 (-)	Analogic balanced input n°7	RV7
12 (+), 25 (-)	Analogic balanced input n°8	RV8
1, 4, 7, 10, 13, 15, 18, 21, 24	Massa	

Obtain the maximum of the voltage and regulate the correspondent trimmer in order to obtain the visualization, on the remote control software, the voltage of 5V. See the software manual to set up correctly the database necessary to have an immediate visualization of the parameter in the right unit of measure.

### 3.3.2 How to control a voltage inferior to 5V

Connect to DB25 marked as DIGITAL/ANALOG INPUT on the PIN described in the table:

Pin number	Meant	Jumper su JP4
2	Digital/analogic unbalanced input n°1	pos. 1
15	Digital/analogic unbalanced input n°2	pos. 2
3	Digital/analogic unbalanced input n°3	pos. 3
16	Digital/analogic unbalanced input n°4	pos. 4
4	Digital/analogic unbalanced input n°5	pos. 5
17	Digital/analogic unbalanced input n°6	pos. 6
5	Digital/analogic unbalanced input n°7	pos. 7
18	Digital/analogic unbalanced input n°8	pos. 8
21	Digital/analogic unbalanced input n°9	pos. 9
9	Digital/analogic unbalanced input n°10	pos. 10
22	Digital/analogic unbalanced input n°11	pos. 11
10	Digital/analogic unbalanced input n°12	pos. 12
23	Digital/analogic unbalanced input n°13	pos. 13
11	Digital/analogic unbalanced input n°14	pos. 14
24	Digital/analogic unbalanced input n°15	pos. 15
12	Digital/analogic unbalanced input n°16	pos. 16
1, 6, 7, 8, 13, 14, 19, 20, 25	GND	

Obtain the visualization, on the remote control software, of the parameter. See the software manual to set up correctly the database necessary to have an immediate visualization of the parameter in the right unit of measure.

### 3.3.3 How use the relay outputs

Remembering that in figure is represented schematically the Off relay condition and that the disposition of the contacts in the connector is described in the following table.

Pin number	Meant
1 (C), 14 (NC), 2 (NO)	Relay n°1
15 (C), 3 (NC), 16 (NO)	Relay n°2
4 (C), 17 (NC), 5 (NO)	Relay n°3
18 (C), 6 (NC), 19 (NO)	Relay n°4
7 (C), 20 (NC), 8 (NO)	Relay n°5
21 (C), 9 (NC), 22 (NO)	Relay n°6
10 (C), 23 (NC), 11 (NO)	Relay n°7
24 (C), 12 (NC), 25 (NO)	Relay n°8
13	GND

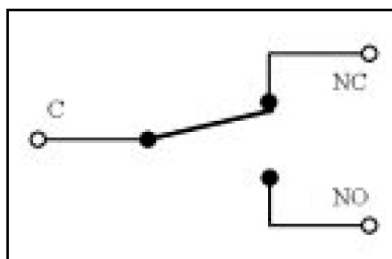

The maximum current that could be made flow through the contacts is of 500mA to 24V.

See the manual of the software to move the relay and set up the necessary database correctly to have the operationing of the relay adjusted to the demands.

## 4. Commands from remote (TLC)

Through these commands sends under form of SMS they could be modified the states of any exits and activate any functions of the TLC.

- INFO: Sending this message as SMS from any mobile phone, you must have in answered an other SMS with the number and name of the station, the forward and reflected power present in percentage and the currents alarms.
- ALARM: Sending this message as SMS from any mobile phone, you must have in answered an other SMS with the number and name of the station, the forward and reflected power present in percentage, name and number of the last 6 alarms currently in memory.
- TXON: Sending this message as SMS from any mobile phone, it moves the relay 1 of the base telemetry card n.1 in TOGGLE\_OFF modality and you must have in answered an other SMS message with the number, name of the station and the wording " Comand SMS Ok".
- TXOFF: Sending this message as SMS from any mobile phone, it moves the relay 2 of the base telemetry card n.1 in TOGGLE\_OFF modality and you must have in answered an other SMS message with the number, name of the station and the wording " Comand SMS Ok".
- OUTON (out): Sending this message as SMS from any mobile phone, it moves the relay "num", in the programmed formality, of the last telemetry card and you must have in answered an other SMS message with number, name of the station and the wording "Comand SMS Ok".
- OUTOFF (out): Sending this message as SMS from any mobile phone, it moves the relay "num", in the programmed formality, of the last telemetry card and you must have in answered an other SMS message with number, name of the station and the wording "Comand SMS Ok".
- RESET: Sending this message as SMS from any mobile phone, it reset the present alarms in memory and and you must have in answered an other SMS message with number, name of the station and the wording " Comand SMS Ok".

*This page was intentionally left blank*



## 5. Messages on the Modem State (only TLC2000)

In this section is described the visualization of the messages state on the display regarding the modem.

These messages could be in the angle aloft to the right of the display, on the frontal panel (only of TLC2000) and they inform on the modem current state.

These messages could be:

- **Init:** Questo messaggio informa che il modem deve ancora essere inizializzato e quindi la procedura di inizializzazione e' ancora in corso.
- **StdBy:** Il modem e' inizializzato ed in attesa di comandi come si può vedere anche dall'apposito LED posto sempre sul pannello frontale.
- **wait:** Questo messaggio informa che il modem sta tentando di eseguire un'operazione di invio messaggio o di connessine con altro modem.
- **NoDia:** Questo messaggio informa che il modem in seguito ad una richiesta di operazione non riesce a comunicare.
- **Init:** This message informs that the modem owes still have initialized and therefore the procedure of initialization is still in course.
- **StdBy:** The modem is inizialized and waiting to orders like it could also be seen from the set relative LED always on the frontal panel.
- **Wait:** This message informs that the modem is trying to perform an operation of dispatch message or of connection with other modem.
- **NoDia:** This message informs that the modem in succession to an application of operation is not able to communicate.
- **?Busy:** This message informs that the modem is busy and it is ignoring the order that comes him given.
- **OkCon:** This message informs that the modem communicates with the outside and is sending a message in SMS or normal form.
- **Send>:** This message informs that the modem the is about to send message.
- **Ok!:** This message informs that the modem has sent the SMS with success.
- **Hang:** (only PSTN) This message informs that the modem is effecting the procedure of Hang up and therefore it is interrupting the communication.

*This page was intentionally left blank*