



# URPT/MIC & URPR/ MIC

USER MANUAL  
VOLUME1



**File Name:** URPT&URPR\_MIC\_ING\_1.1.indb

**Version:** 1.1

**Date:** 29/06/2012

### Revision History

Date	Version	Reason	Editor
20/05/2011	1.0	First Version	J. H. Berti
29/06/2012	1.1	Technical specification upgrade	J. H. Berti

URPT/MIC & URPR/ MIC - User Manual  
Version 1.1

© Copyright 2011-2012

R.V.R. Elettronica SpA

Via del Fonditore 2/2c - 40138 - Bologna (Italia)

Telephone: +39 051 6010506

Fax: +39 051 6011104

Email: info@rvr.it

Web: www.rvr.it

All rights reserved

Printed and bound in Italy. No part of this manual may be reproduced, memorized or transmitted in any form or by any means, electronic or mechanic, including photocopying, recording or by any information storage and retrieval system, without written permission of the copyright owner.

#### **Notification of intended purpose and limitations of product use**

This product is a FM transmitter intended for FM audio broadcasting. It utilises operating frequencies not harmonised in the intended countries of use.

The user must obtain a license before using the product in intended country of use. Ensure respective country licensing requirements are complied with.

Limitations of use can apply in respect of operating frequency, transmitter power and/or channel spacing.

#### **Declaration of Conformity**

Hereby, R.V.R. Elettronica SpA, declares that this FM transmitter is in compliance with the essential requirements and other relevant provisions of Directive 1999/5/EC.



# Table of Contents

<b>1.</b>	<b>Preliminary Instructions</b>	<b>1</b>
<b>2.</b>	<b>Warranty</b>	<b>1</b>
<b>3.</b>	<b>First Aid</b>	<b>2</b>
3.1	Treatment of electrical shocks	2
3.2	Treatment of electrical Burns	2
<b>4.</b>	<b>General Description</b>	<b>3</b>
4.1	Unpacking	3
4.2	Features	3
4.3	URPT/MIC Frontal Panel Description	7
4.4	URPT/MIC Rear Panel Description	8
4.5	URPT/MIC Connector Description	9
4.6	URPR/MIC Frontal Panel Description	11
4.7	URPR/MIC Rear Panel Description	12
4.8	URPR/MIC Connector Description	13
4.9	URPT/MIC Technical Description	15
4.10	URPR/MIC Technical Description	17
<b>5.</b>	<b>URPT/MIC quick guide for installation and use</b>	<b>18</b>
5.1	Preparation	18
5.2	First power-on and setup	21
5.3	Operation	22
5.4	Management Firmware	24
<b>6.</b>	<b>URPR/MIC quick guide for installation and use</b>	<b>30</b>
6.1	Preparation	30
6.2	First power-on and setup	21
6.3	Operation	22
6.4	Management Firmware	24
<b>7.</b>	<b>Identification and Access to the Modules</b>	<b>40</b>
7.1	URPT/MIC Upper View	40
7.2	URPR/MIC Upper View	40

*This page was intentionally left blank*

## IMPORTANT



The symbol of lightning inside a triangle placed on the product, evidences the operations for which is necessary gave it full attention to avoid risk of electric shocks.



The symbol of exclamation mark inside a triangle placed on the product, informs the user about the presence of instructions inside the manual that accompanies the equipment, important for the efficacy and the maintenance (repairs).

## 1. Preliminary Instructions

### • General Warnings

This equipment should only be operated, installed and maintained by "trained" or "qualified" personnel who are familiar with risks involved in working on electric and electronic circuits. "Trained" means personnel who have technical knowledge of equipment operation and who are responsible for their own safety and that of other unqualified personnel placed under their supervision when working on the equipment.

"Qualified" means personnel who are trained in and experienced with equipment operation and who are responsible for their own safety and that of other unqualified personnel placed under their supervision when working on the equipment.

**⚡ WARNING: Residual voltage may be present inside the equipment even when the ON/OFF switch is set to Off. Before servicing the equipment, disconnect the power cord or switch off the main power panel and make sure the safety earth connection is connected. Some service situations may require inspecting the equipment with live circuits. Only trained and qualified personnel may work on the equipment live and shall be assisted by a trained person who shall keep ready to disconnect power supply at need.**

R.V.R. Elettronica S.p.A. shall not be liable for injury to persons or damage to property resulting from improper use or operation by trained/untrained and qualified/unqualified persons.

**⚡ WARNING: The equipment is not water resistant. Any water entering the enclosure might impair proper operation. To prevent the risk of electrical shock or fire, do not expose this equipment to rain, dripping or moisture.**

Please observe local codes and fire prevention rules when installing and operating this equipment.

**⚡ WARNING: This equipment contains exposed live parts involving an electrical shock hazard. Always disconnect power supply before removing any covers or other parts of the equipment.**

Ventilation slits and holes are provided to ensure reliable operation and prevent overheating; do not obstruct or cover these slits. Do not obstruct the ventilation slits under any circumstances. The product must not be incorporated in a rack unless adequate ventilation is provided or the manufacturer's instructions are followed closely.

**⚠ WARNING: This equipment can radiate radiofrequency energy and, if not installed in compliance with manual instructions and applicable regulations, may cause interference with radio communications.**

**⚠ WARNING: This equipment is fitted with earth connections both in the power cord and for the chassis.**

### Make sure both are properly connected.

Operation of this equipment in a residential area may cause radio interference, in which case the user may be required to take adequate measures.

The specifications and data contained herein are provided for information only and are subject to changes without prior notice. R.V.R. Elettronica S.p.A. disclaims all warranties, express or implied. While R.V.R. Elettronica S.p.A. attempts to provide accurate information, it cannot accept responsibility or liability for any errors or inaccuracies in this manual, including the products and the software described herein. R.V.R. Elettronica S.p.A. reserves the right to make changes to equipment design and/or specifications and to this manual at any time without prior notice.

### • Notice concerning product intended purpose and use limitations.

This product is a radio transmitter suitable for frequency-modulation audio radio broadcasting. Its operating frequencies are not harmonised in designated user countries. Before operating this equipment, user must obtain a licence to use radio spectrum from the competent authority in the designated user country. Operating frequency, transmitter power and other characteristics of the transmission system are subject to restrictions as specified in the licence.

## 2. Warranty

La R.V.R. Elettronica S.p.A. warrants this product to be free from defects in workmanship and its proper operation subject to the limitations set forth in the supplied Terms and Conditions. Please read the Terms and Conditions carefully, as purchase of the product or acceptance of the order acknowledgement imply acceptance of the Terms and Conditions. For the latest updated terms and conditions, please visit our web site at WWW.RVR.IT. The web site may be modified, removed or updated for any reason whatsoever without prior notice. The warranty will become null and void in the event the product enclosure is opened, the product is physically damaged, is repaired by unauthorised persons or is used for purposes other than its intended use, as well as in the event of improper use, unauthorised changes or neglect. In the event a defect is found, follow this procedure:

- 1 Contact the seller or distributor who sold the equipment; provide a description of the problem or malfunction for the event a quick fix is available.

Sellers and Distributors can provide the necessary information to troubleshoot the most frequently encountered problems. Normally, Sellers and Distributors can offer a faster repair service than the Manufacturer would. Please note that Sellers can pinpoint problems due to wrong installation.

- 2 If your Seller cannot help you, contact R.V.R. Elettronica S.p.A. and describe the problem; if our staff deems it appropriate, you will receive an authorisation to return the equipment along with suitable instructions;

- 3 When you have received the authorisation, you may return the unit. Pack the unit carefully before shipment; use the original packaging whenever possible and seal the package perfectly. The customer bears all risks of loss (i.e., R.V.R. shall not be liable for loss or damage) until the package reaches the R.V.R. factory. For this reason, we recommend insuring the goods for their full value. Returns must be sent on a C.I.F. basis (PREPAID) to the address stated on the authorisation as specified by the R.V.R. Service Manager.



Units returned without a return authorisation may be rejected and sent back to the sender.

- 4 Be sure to include a detailed report mentioning all problems you have found and copy of your original invoice (to show when the warranty period began) with the shipment.

Please send spare and warranty replacement parts orders to the address provided below. Make sure to specify equipment model and serial number, as well as part description and quantity.



R.V.R. Elettronica S.p.A.  
Via del Fonditore, 2/2c  
40138 BOLOGNA ITALY  
Tel. +39 051 6010506

## 3. First Aid

All personnel engaged in equipment installation, operation and maintenance must be familiar with first aid procedures and routines.

### 3.1 Electric shock treatment

#### 3.1.1 If the victim is unconscious

Follow the first aid procedures outlined below.

- Lay the victim down on his/her back on a firm surface.
- the neck and tilt the head backwards to free the airway system (**Figure 1**).

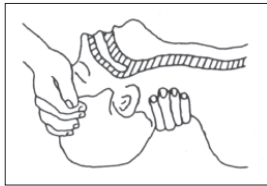

Figure 1

- If needed, open the victim's mouth and check for breathing.
- If there is no breathing, start artificial respiration without delay (**Figure 2**) as follows: tilt the head backwards, pinch the nostrils, seal your mouth around the victim's mouth and give four fast rescue breaths.



Figure 2

- Check for heartbeat (**Figure 3**); if there is no heartbeat, begin chest compressions immediately (**Figure 4**) placing your hands in the centre of the victim's chest (**Figure 5**).

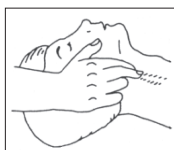

Figure 3

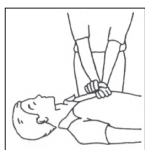

Figure 4

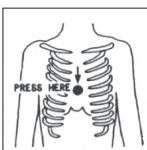

Figure 5

- One rescuer: give 2 quick rescue breaths after each 15 compressions.
- Two rescuers: one rescue breath after each 5 compressions.

- Do not stop chest compressions while giving artificial breathing.
- Call for medical help as soon as possible.

#### 3.1.2 If the victim is conscious

- Cover victim with a blanket.
- Try to reassure the victim.
- Loosen the victim's clothing and have him/her lie down.
- Call for medical help as soon as possible.

### 3.2 Treatment of electric burns

#### 3.2.1 Large burns and broken skin

- Cover affected area with a clean cloth or linen.
- Do not break any blisters that have formed; remove any clothing or fabric that is stuck to the skin; apply adequate ointment.
- Administer adequate treatment for the type of accident.
- Get the victim to a hospital as quickly as possible.
- Elevate arms and legs if injured.

If medical help is not available within an hour, the victim is conscious and is not retching, administer a solution of table salt and baking soda (one teaspoon of table salt to half teaspoon of baking soda every 250 ml of water).

Have the victim slowly drink half a glass of solution for four times during a period of 15 minutes.

Stop at the first sign of retching.

Do not administer alcoholic beverages.

#### 3.2.2 Minor burns

- Apply cold (not ice cold) strips of gauze or dress wound with clean cloth.
- Do not break any blisters that have formed; remove any clothing or fabric that is stuck to the skin; apply adequate ointment.
- If needed, have the victim change into clean, dry clothing.
- Administer adequate treatment for the type of accident.
- Get the victim to a hospital as quickly as possible.
- Elevate arms and legs if injured.

## 4. General Description

The **URPT/MIC** and **URPR/MIC** (microphonic version) are, respectively a broadband radio transmitter and receiver for the transport of audio signals as an auxiliary to the frequency modulation sound broadcasting.

The **URPT/MIC** is designed to work in an optimum way when connected to the receiver **URPR/MIC**.

This type of equipment is designed to be used as a portable unit. This narrow-band modulator is designed to carry “out of studio” interviews by journalists, direct “on the field” and so on; while the receiver is designed for employment also on motor vehicles (both light and heavy), or installation with low environmental impact supplies by batteries or photovoltaic panels.

### 4.1 Unpacking

The package contains:

- 1 **URPT/MIC** and/or **URPR/MIC**
- 1 User Manual
- 1 Mains power cable

The following accessories are also available from Your R.V.R. Dealer:

- **Accessories, spare parts and cables**

### 4.2 Features

The standard working frequency bands are the following:

- **/B10**: 190 ÷ 310
- **/B20**: 315 ÷ 400
- **/B30**: 405 ÷ 465
- **/B40**: 470 ÷ 545
- **/B50**: 780 ÷ 885
- **/B60**: 890 ÷ 970



**Note:** the working frequency (and therefore the band) should be indicated when the order for such product is placed.



**Note:** upon request, these links are available at other frequency bands and steps, please contact RVR in order to check the availability of modules at the required frequency.

The **URPT/MIC** contain a low-pass filter that reduces the harmonic emission to provided for by international standards (CCIR, FCC or ETSI) and can be connected directly to the antenna.

The RF power section of **URPT/MIC** features a MOSFET module delivering up to 40W output power.

Operating frequency stability is ensured by a temperature-compensated reference oscillator and is maintained by a PLL (Phase Locked Loop) system. The exciters will go into frequency lock within 30 seconds after power-on.

On the front panel there are four input connectors for the balanced audio signal (impedance 2,2 Kohm) and its audio level controls, switches for the level selection (MIC-LINE), four switches to activate the prelistening service and its level control, switch to power on/off the service microphone.



**IMPORTANT:** *on service microphone input there is a bias voltage to use ELECTRET microphones, if the microphone in use does not need this bias voltage and you want to turn it off, move the jumper JP3 on the audio panel card (SL137PC1002) from position 2-3 to position 1-2.*

On rear panel are present the input mains connector, the RF output connector, the service connector and accessory connector for connection to external machine or rescue battery.

In the standard version of the **URPR/MIC**, the demodulated signal is available in the MPX form (that is to say the complete basis signal band) and in the mono version.

Moreover there is one connector used for SCA output as an option, the **URPR/MIC** can be equipped with a stereo decoder option. Also when this option is present, apart from the outputs for the LEFT and RIGHT channels, the outputs for the MPX signal are present and for the possible sub-carriers.

On rear panel are present the input mains connector, the RF input connector, the service connector and accessory connector for connection to external machine or rescue battery.

The important audio characteristics of this equipment are the low distortion and intermodulation values and the high S/N level; another important quality both of the **URPT/MIC** and the **URPR/MIC** is its very simple construction and its easy use.

Both the **URPT/MIC** and the **URPR/MIC** were designed in a modular way: the different functions are executed by modules connected directly with male and female connectors or with flat cables with connectors at both ends. This type of design makes the maintenance and the possible replacement of modules an easy operation.





The microprocessor system includes an LCD display and an encoder that enable the interaction with the user, and implements the following functions for the transmitter:

- Display of the modulation
- Setting of the output power
- Setting of the working frequency
- Power Good feature (User-selectable output power alarm threshold).
- Measurement and display of the working parameters of the transmitter
- Communications with external devices such as programming systems, or telemetry systems, via SERVICE serial interface.

These functions are implemented for the receiver:

- Display of the modulation
- Setting of the working frequency
- Setting of the muting threshold
- Measurement and display of the working parameters of the receiver
- Communications with external devices such as programming systems, or telemetry systems, via SERVICE serial interface.

The **URPT/MIC** and **URPR/MIC** management firmware is based on a menu system. User has four navigation buttons available to browse submenus: **ESC** ,  ,  , and **ENTER**.

The status of the unit is indicated by four LEDs which are present on the front panel:



- ENCODER ON, POWER ON, PLL LOCK, PWR OUT FOLDBACK, RF MUTE for **URPT/MIC**.
- ENCODER PRESENT, POWER ON, PLL LOCK, PILOT PRESENT, AUDIO MUTE for **URPR/MIC**.

Both the transmitter and the receiver, through the SERVICE connector, have an input for the external 12 or 24 V<sub>DC</sub> supply. This auxiliary supply source, that can be realized by the user with the help of rescue batteries, is automatically used in case of AC voltage absence.

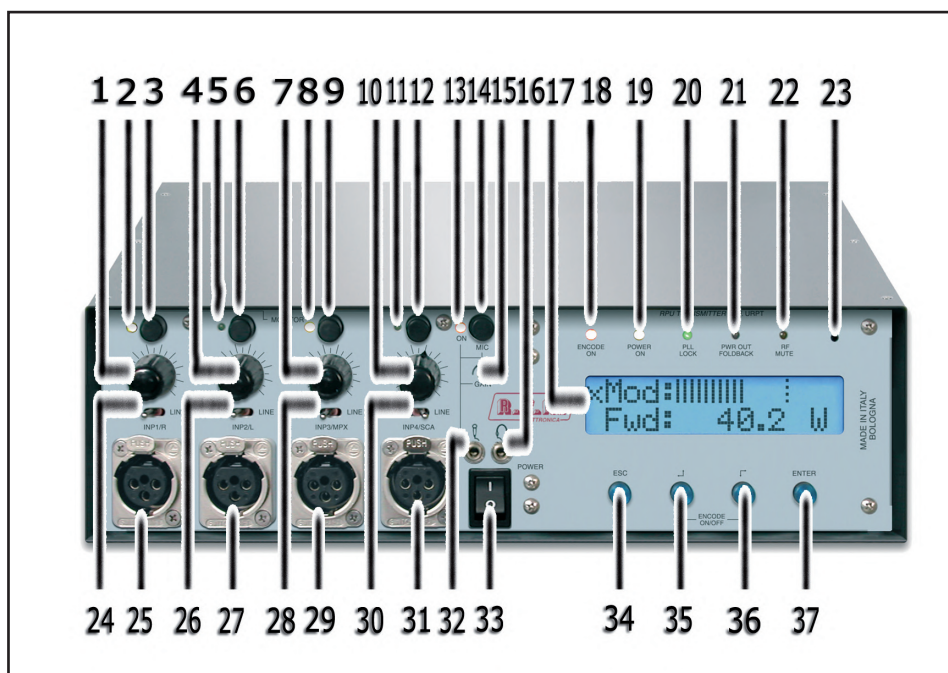
## 4.3 URPT/MIC Frontal Panel Description



- |                        |  |
|------------------------|--|
| [1] INP1 KNOB          | INPUT 1 level adjusting knob.  |
| [2] INP1 LED           | Green LED - light on when the INPUT 1 is in prelistening.  |
| [3] INP1 BUTTON        | Push button to put INPUT 1 in prelistening.  |
| [4] INP2 KNOB          | INPUT 2 level adjusting knob.  |
| [5] INP2 LED           | Green LED - light on when the INPUT 2 is in prelistening.  |
| [6] INP2 BUTTON        | Push button to put INPUT 2 in prelistening.  |
| [7] INP3 KNOB          | INPUT 3 level adjusting knob.  |
| [8] INP3 LED           | Green LED - light on when the INPUT 3 is in prelistening.  |
| [9] INP3 BUTTON        | Push button to put INPUT 3 in prelistening.  |
| [10] INP4 KNOB         | INPUT 4 level adjusting knob.  |
| [11] INP4 LED          | Green LED - light on when the INPUT 4 is in prelistening.  |
| [12] INP4 BUTTON       | Push button to put INPUT 4 in prelistening.  |
| [13] MIC ON LED        | Green LED - light on when the microphone input is selected.  |
| [14] MIC BUTTON        | Push button to enable the microphone input.  |
| [15] MIC GAIN          | Adjustment trimmer of volume for microphone jack.  |
| [16] HEADPHONES        | Jack connector for headphones. Dual-mono output.   |
| [17] DISPLAY           | Liquid crystals display.   |
| [19] ENCODER ON        | Red LED - light on when the 27 Hz subtone is enabled.  |
| [19] POWER ON          | Green LED - light on when the exciter is working.  |
| [20] PLL LOCK          | Green LED - light on when PLL is locked on working frequency.  |
| [21] PWR OUT FOLDBACK  | Yellow LED - light on when the Automatic Gain Control function works correctly.                      |
| [22] R.F. MUTE         | Yellow LED - light on when the exciter's power output is inhibited by an external interlock command. |
| [23] CONTRAST          | Display contrast adjusting trimmer.  |
| [24] MIC/LINE SWITCH 1 | Commutation switch between microphone and line level.  |
| [25] INP 1             | XLR balanced connector for microphonic or line input 1.  |
| [26] MIC/LINE SWITCH 2 | Commutation switch between microphone and line level.  |
| [27] INP 2             | XLR balanced connector for microphonic or line input 2.  |
| [28] MIC/LINE SWITCH 3 | Commutation switch between microphone and line level.  |
| [29] INP 3             | XLR balanced connector for microphonic or line input 3.  |
| [30] MIC/LINE SWITCH 4 | Commutation switch between microphone and line level.  |
| [31] INP 4             | XLR balanced connector for microphonic or line input 4.  |
| [32] MIC               | Jack connector for microphone.   |

[33] POWER	ON/OFF switch.
[34] ESC	Push button to exit from a menu.
[35] 	Push button to move in the menu system and to modify the parameters.
[36] 	Push button to move in the menu system and to modify the parameters.
[37] ENTER	Push button to confirm a parameter and to enter in a menu.

## 4.4 URPT/MIC Rear Panel Description

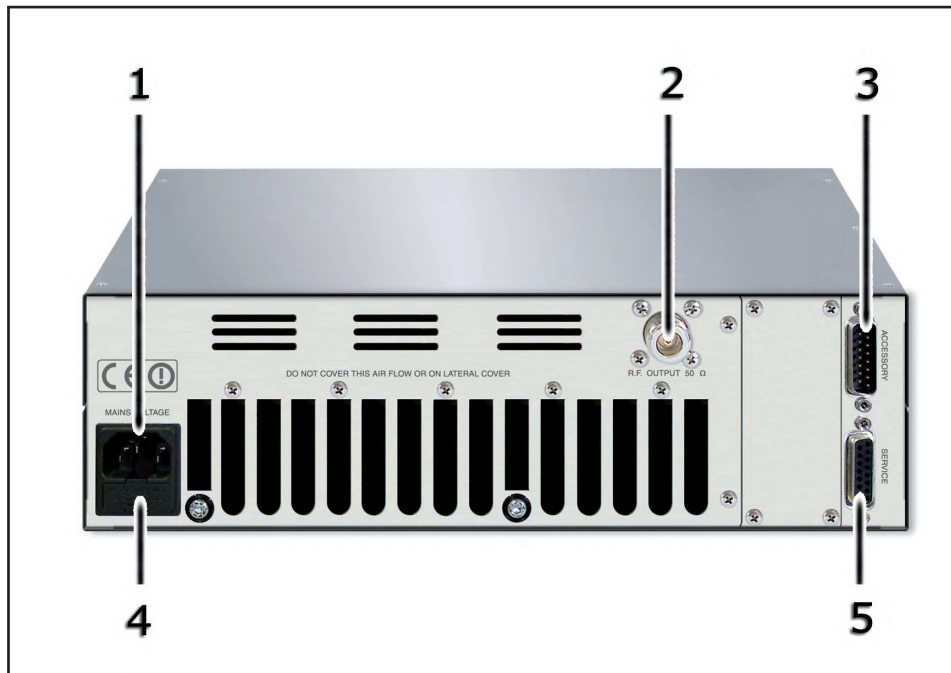

- |                 |  |
|-----------------|--|
| [1] PLUG        | VDE plug for mains supply.   |
| [2] R.F. OUTPUT | RF output connector, N-type, 50 Ω  |
| [3] ACCESSORY   | DB15 male connector for interconnection with other devices (i.e. external battery).                                |
| [4] FUSE BLOCK  | Fuse carrier. Use a screwdriver to access the fuse. Includes a fuse for general protection regarding power supply. |
| [5] SERVICE     | DB15 female connector for the telemetry of equipment.  |

## 4.5 URPT/MIC Connector Description

### 4.5.1 Service

Type: Female DB15

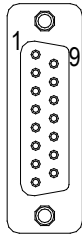

Pin	Name	Type	Meaning
1	Interlock	IN	Pull-up 5V (if grounded, it inhibits the RF power)
2	FWD Foldback		Ext. signal, 1-12V, for power limitation (AGC)
3	GND		Ground
4	Reserved		
5	VPA TIm	ANL OUT	PA power supply voltage: 3.9V F.S.
6	FWD TIm	ANL OUT	Forward power: 3.9V F.S.
7	Power Good	DIG OUT	Open collector (if grounded, it enable the power good).
8	GND		Ground
9	GND		Ground
10	Ext AGC RFL	IN	Ext. signal, 1-12V, for power limitation (AGC)
11	Reserved		
12	IPA TIm	ANL OUT	PA power supply current: 3.9V F.S.
13	RFL TIm	ANL OUT	Reflected power: 3.9V F.S.
14	On cmd	DIG IN	One grounded pulse (500 ms) enables RF.
15	OFF cmd	DIG IN	One grounded pulse (500 ms) disables RF.

### 4.5.2 Accessory

Type: Male DB15

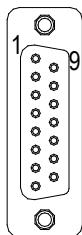

Pin	Meaning
1	GND
2	DC+ (IN) from 9 to 30V
3	DC+ (IN) from 9 to 30V
4	External Balanced Audio
5	External Balanced Audio
6	DC+ (IN) from 9 to 30V
7	DC+ (IN) from 9 to 30V
8	GND
9	DC+ (IN) from 9 to 30V
10	DC+ (IN) from 9 to 30V
11	GND
12	GND
13	Not Connected
14	DC+ (IN) from 9 to 30V
15	Stand by (IN) Pull-up 5V; if GND then RF OK

## 4.5.3 INP 1, 2, 3 & 4



Type: XLR Female

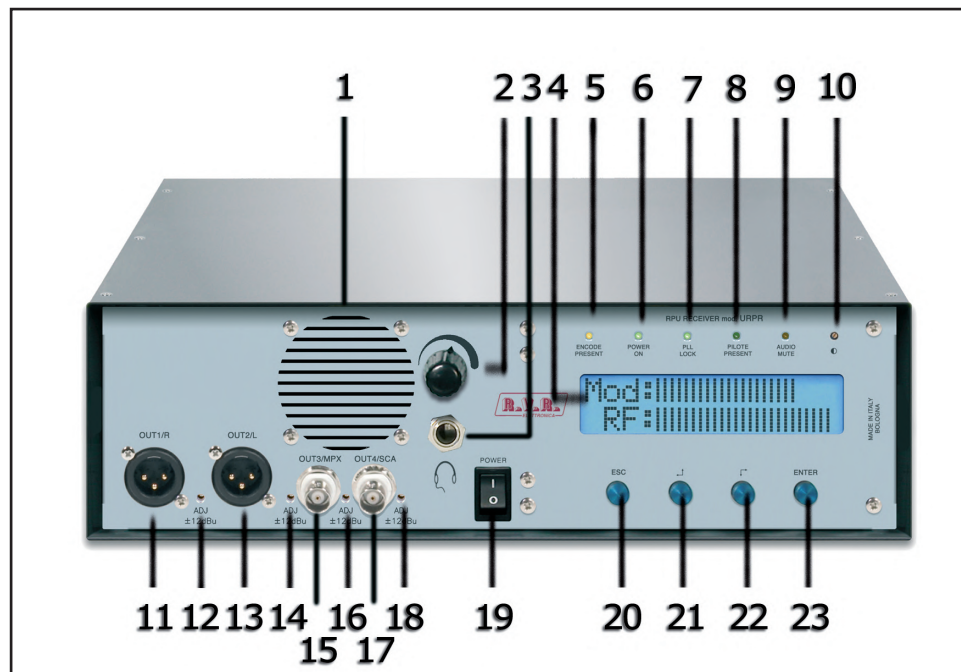

- 1 GND
- 2 Positive
- 3 Negative

## 4.6 URPR/MIC Frontal Panel Description



- |  |  |
|--|--|
| [1] LOUDSPEAKER  | Mono output speaker.   |
| [2] KNOB   | Output level adjusting knob for headphones.  |
| [3] HEADPHONES   | Jack connector for headphones. Dual-mono output.   |
| [4] DISPLAY  | Liquid crystals display.   |
| [5] ENCODER PRESENT  | Red LED - light on when the 27 Hz subtone is present.  |
| [6] POWER ON   | Green LED - light on when the receiver is working.   |
| [7] PLL LOCK   | Green LED - light on when PLL is locked on working frequency.  |
| [8] PILOT PRESENT  | Yellow LED - not used.   |
| [9] AUDIO MUTE   | Yellow LED - light on when the muting is activated, which means that the input signal has decreased under the defined threshold. |
| [10] CONTRAST  | Display contrast adjusting trimmer.  |
| [11] OUT 1/R   | XLR balanced connector for MONO output 1 or RIGHT.   |
| [12] ADJ $\pm 12$ dBu  | Level adjusting trimmer, from $<-12$ to $>+12$ dBu, for MONO output 1 or RIGHT.  |
| [13] OUT 1/R   | XLR balanced connector for MONO output 2 or LEFT.  |
| [14] ADJ $\pm 12$ dBu  | Level adjusting trimmer, from $<-12$ to $>+12$ dBu, for MONO output 2 or LEFT.   |
| [15] OUT 3/MPX   | BNC unbalanced connector for MONO output 3 or MPX.   |
| [16] ADJ $\pm 12$ dBu  | Level adjusting trimmer, from $<-12$ to $>+12$ dBu, for MONO output 3 or MPX.  |
| [17] OUT 4/SCA   | BNC unbalanced connector, from $<-12$ to $>+12$ dBu, for MONO output 4 or SCA.   |
| [18] ADJ $\pm 12$ dBu  | Level adjusting trimmer for MONO output 4 or SCA.  |
| [19] POWER   | ON/OFF switch.   |
| [20] ESC   | Push button to exit from a menu.   |
| [21]  | Push button to move in the menu system and to modify the parameters.   |
| [22]  | Push button to move in the menu system and to modify the parameters.   |
| [23] ENTER   | Push button to confirm a parameter and to enter in a menu.   |

## 4.7 URPR/MIC Rear Panel Description

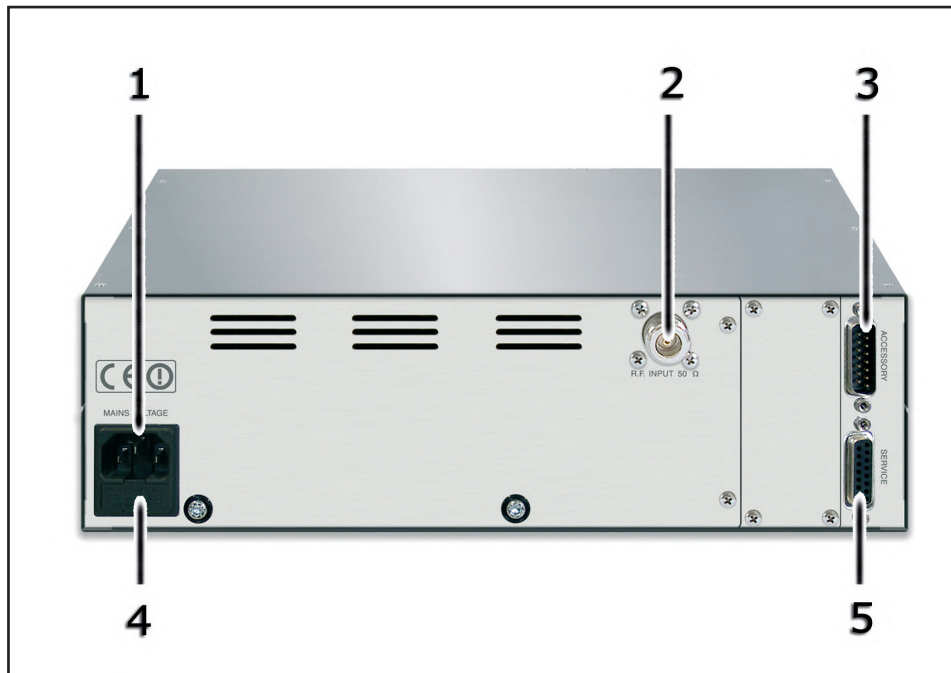

- |                |  |
|----------------|--|
| [1] PLUG       | VDE plug for mains supply.   |
| [2] R.F. INPUT | RF input connector, N-type, 50 $\Omega$  |
| [3] ACCESSORY  | DB15 male connector for interconnection with other devices (i.e. external battery).                                |
| [4] FUSE BLOCK | Fuse carrier. Use a screwdriver to access the fuse. Includes a fuse for general protection regarding power supply. |
| [5] SERVICE    | DB15 female connector for the telemetry of equipment.  |



## 4.8 URPR/MIC Connector Description

### 4.8.1 Service

Type: Female DB15

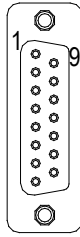

Pin	Name	Type	Meaning
1	Audio Off	IN	Pull-up 5V; if grounded, it inhibits the Audio
2	Not Used		
3	GND		Ground
4	SDA		IIC Bus
5	RF Input Level		
6	OUT2 Level		
7	Squelch Relay N/ODIG OUT		Open collector, enabled when power exceeds the set threshold
8	GND		Ground
9	GND		Ground
10	Not Used		
11	SCL		IIC Bus
12	OUT3 Level		
13	OUT1 Level		
14	On cmd	DIG IN	One grounded pulse (500 ms) enables the AF.
15	OFF cmd	DIG IN	One grounded pulse (500 ms) disables the AF.

### 4.8.2 Accessory

Type: Male DB15

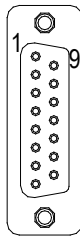

Pin	Meaning
1	GND
2	Squelch relay : N/O
3	Decode level
4	Balanced audio output
5	Balanced audio output
6	Squelch relay : N/O
7	DC input 10-30 V <sub>CC</sub>
8	GND
9	Not connector
10	Decode relay N/C to GND
11	Signal level output
12	Decode relay. closed when present
13	Decode relay. closed when present
14	Not connected
15	RF mute

## 4.8.3 OUT 1/R & 2/L

Type: XLR Male



- 1 GND
- 2 Positive
- 3 Negative

## 4.9 URPT /MIC Technical Description

		URPT/MIC/B...
Parameters	Conditions	Value
<b>GENERALS</b>		
Rated output power		/B10: 30 W /B20: 30 W /B30: 30 W /B40: 40 W /B50: 20 W /B60: 20 W
Modulation type		Direct carrier frequency modulation
Operational mode		ALC ON, ALC OFF
Display		Alphanumerical LCD - 2 x 16
Environmental working temperature		from -10 °C to 50 °C
Frequency range (other frequency on request) Attention: the frequency work bandwidth is 50MHz from 190 to 315 MHz and 26 MHz from 315 to 970 MHz		/B10: 135 ÷ 185 /B20: 215 ÷ 265 /B30: 300 ÷ 350 /B40: 430 ÷ 480 /B50: 780 ÷ 885 /B60: 890 ÷ 970
Frequency programmability		5 KHz step, other step available upon request
Frequency stability	WT from -10°C to 50°C	±1 ppm
Modulation Capability		7,5 KHz @ 0dBu
Spurious & harmonic suppression		<70 dBc
Asynchronous AM S/N ratio	Referred to 100% AM, without de-emphasis	≥ 60 dBc
Synchronous AM S/N ratio	Referred to 100% AM, FM deviation 400Hz sine, without de-emphasis	≥ 50 dBc ( @ ± 7,5 kHz peak of deviation)
Audio Filters		5 / 7,5 / 10 / 12,5 KHz
Preemphasis		0, 50µS (CCIR), 75µS (FCC), 750 µS
<b>MONO OPERATION</b>		
S/N FM	RMS , HPF 20Hz - LPF 23 kHz, 50 µS de-emphasis	≥ 52 dB (RMS @ ± 7,5 kHz peak)
<b>MPX OPERATION</b>		
S/N FM	RMS, HPF 20Hz - no LPF	Not available
Frequency response	40 Hz ÷ 100 KHz	Not available
Total Harmonic Distortion	THD+N 40 Hz ÷ 100 KHz	Not available
<b>STEREO OPERATION</b>		
S/N FM	RMS @ ± 75 kHz peak, HPF 20Hz - LPF 23 kHz, 50 µS de-emphasis, L & R demodulated	Not available
Frequency response	40 Hz ÷ 15 KHz	Not available
Total Harmonic Distortion	THD+N 40 Hz ÷ 15 KHz	Not available
Stereo separation		Not available
<b>AUDIO INPUTS</b>		
Input 1	Connector	XLR F
	Type	balanced
	Impedance	600, 2,2 or 10 k (Ohm), selectable with internal solder pad
Input 2	Connector	XLR F
	Type	balanced
	Impedance	600, 2,2 k or 10 k (Ohm), selectable with internal solder pad
Input 3	Connector	XLR F
	Type	unbalanced
	Impedance	600, 2,2 k or 10 k (Ohm), selectable with internal solder pad
Input 4	Connector	XLR F
	Type	unbalanced
	Impedance	600, 2,2 k or 10 k (Ohm), selectable with internal solder pad

Service microphone	Connector	3,5 mm Jack
	Type	Mono, internal selectable phantom power (for electret mic)
<b>OUTPUTS</b>		
RF output	Type	N Type
	Impedance	50 Ohm
Headphone output	Type	3,5 mm Jack
	Impedance	25 Ohm
	Level	Max 200 mW
<b>AUXILIARY CONNECTIONS</b>		
Accessory Interface	Connector	DB15 M
Telemetry Interface	Connector	DB15 F
<b>POWER REQUIREMENTS</b>		
AC Primary power	AC Supply Voltage	90 ÷ 130 or 180 ÷ 250 VAC
	AC Power Consumption	about 200 W
	Connector	IEC Standard
DC Power Input	DC Supply Voltage	12-30 V
	DC Current	< 13 A
	DC Power Consumption	about 140 W
	Connector	DB15 (ACCESSORY)
<b>MECHANICAL SPECIFICATION</b>		
Physical Dimensions (W x H x		355x85x295 mm
Weight		About 4 Kg
<b>STANDARD COMPLIANCE</b>		
SAFETY		EN 60215:1989 + EN60215/A1:1992-07 + EN60215/A2:1994-09
EMC		EN 301 489-1 V1.4.1 (2002-08) + EN 301 489-11 V1.2.1 (2002-11)
Spectrum Optimization		EN 302 018-2 V1.2.1 (2005-06)
<b>OPTIONS</b>		
/75-URPT		75 KHz modulation URPT/MIC option

## 4.10 URPR /MIC Technical Description

		URPR/MIC/B...
Parameters	Conditions	Value
<b>GENERALS</b>		
Frequency range (other frequency on request)		<b>/B10:</b> 135 ÷ 185 <b>/B20:</b> 215 ÷ 265 <b>/B30:</b> 300 ÷ 350 <b>/B40:</b> 430 ÷ 480 <b>/B50:</b> 780 ÷ 885 <b>/B60:</b> 890 ÷ 970
Demodulation type		FM
Display		Alphanumerical LCD - 2 x 16
Environmental working temperature		from -10 °C to 50 °C
RF input impedance		50 Ohm
Frequency programmability		from software step 10kHz
Frequency stability	WT from -10°C to 50°C	±1 ppm
Deemphasis		0, 50 µS (CCIR), 75µS (FCC), 750 µS (internally selectable by jumper)
Intermediary Frequencies (IF)		IF: 70 MHz / 10,7 / 700 kHz
<b>MONO OPERATION</b>		
S/N FM	RF INPUT -47 dBm, RMS @ ± 7 kHz peak, HPF 20Hz - LPF 23 kHz , 75 µS deemphasis	50 dB
Frequency response	40 Hz ÷ 12,5 kHz, 75 µS deemphasis	± 0,5 dB
Total Harmonic Distortion	THD+N 40 Hz ÷ 15 KHz	≤ 3%
<b>INPUTS</b>		
RF input	Connector	N Type
	Impedance	50 Ohm
<b>OUTPUTS</b>		
Mono front (one pair)	Connector	XLR Male
	Type	balanced
	Level	from <-12 to >+12 dBu
Mono front	Connector	BNC
	Type	Unbalanced
	Level	from <-12 to >+12 dBu
Mono rear	Connector	DB15 M
	Type	Balanced
	Level	from <-12 to >+12 dBu
Headphone output	Type	3,5 mm Jack
	Impedance	25 Ohm
	Level	Max 200 mW
<b>AUXILIARY CONNECTIONS</b>		
Accessory Interface	Connector	DB15 M
Telemetry Interface	Connector	DB15 F
<b>POWER REQUIREMENTS</b>		
AC Primary power	AC Supply Voltage	90 ÷ 250 VAC
	AC Power Consumption	about 40 VA
	Connector	IEC Standard
DC Power Input	DC Supply Voltage	12-30 V
	DC Current	< 2,5 A
	DC Power Consumption	about 30 W
	Connector	DB15 (ACCESSORY)
<b>MECHANICAL SPECIFICATION</b>		
Physical Dimensions (W x H x D)		355x85x295 mm
Weight		About 3,5 Kg
<b>STANDARD COMPLIANCE</b>		
SAFETY		EN 60215:1989 + EN60215/A1:1992-07 + EN60215/A2:1994-09
EMC		EN 301 489-1 V1.4.1 (2002-08) + EN 301 489-11 V1.2.1 (2002-11)
Spectrum Optimization		EN 302 018-2 V1.2.1 (2005-06)

## 5. URPT/MIC quick guide for installation and use

This section provides a step-by-step description of equipment installation and configuration procedure. Follow these procedures closely upon first power-on and each time any change is made to general configuration, such as when a new transmission station is added or the equipment is replaced.

Once the desired configuration has been set up, no more settings are required for normal operation; at each power-up (even after an accidental shutdown), the equipment defaults to the parameters set during the initial configuration procedure.

The topics covered in this section are discussed at greater length in the next sections, with detailed descriptions of all hardware and firmware features and capabilities. Please see the relevant sections for additional details.



**IMPORTANT:** *When configuring and testing the transmitter in which the equipment is integrated, be sure to have the Final Test Table supplied with the equipment ready at hand throughout the whole procedure; the Final Test Table lists all operating parameters as set and tested at the factory.*

### 5.1 Preapation

#### 5.1.1 Preliminary checks

Unpack the exciter and immediately inspect it for transport damage. Ensure that all connectors are in perfect condition.

Provide for the following (applicable to operating tests and putting into service):

- √ Single-phase 90÷130 VAC or 180÷250 VAC mains power supply, with adequate earth connection.
- √ For operating tests only: dummy load with 50 Ohm impedance and adequate capacity (40W as a minimum).
- √ Connection cable kit including:
  - Mains power cable or external power cable (i.e. battery via ACCESSORY connector).
  - RF cable for output to load / antenna (50 Ohm coaxial cable with N-type connector).
  - Audio cables between transmitter and audio sources (microphone and/or headphones).

## 5.1.2 Mains Power Supply



**WARNING: Disconnect mains power supply before beginning these procedures.**

The power supply unit is equipped with own fuses; **check all fuses and voltage selection block to ensure they are properly rated for the power mains and change them as required to match mains voltage.**

All mains power supply protection fuses are conveniently located on the rear panel and on left side, easily accessed from the outside: to check or replace a fuse, disconnect **equipment from power mains**, unscrew fuse cover and pull fuse out of socket.

The following fuses are used:

	<i>Main Fuses</i>
URPT/MIC (Mic. Version) <i>On Mains</i>	(1x) 3.15T 5x20 type
URPT/MIC (Mic. Version) <i>On DC Power Input</i>	(1x) 20F automotive

Table 5.1: **Fuses**

Ensure that the equipment is appropriately set for available mains voltage (supply voltage rating is reported in the Final Test Table) as follows: **disconnect equipment from mains** and ensure that the voltage selection block of the power supply, located under the equipment, is set to the appropriate voltage; change setting as required.

The exciter, through the ACCESSORY connector, has an input for external power supply which accepts voltages from about 10,5 to 30 VDC. This source of auxiliary power supply, which can be used by the user through batteries, has a control that automatically turns off the power if the voltage falls too much and prevent irreparable damage: the exciter will turn off when the battery voltage reaches the 10,5 V and will switch on with 11,5 V (by factory).

If you want to use the battery at 24 V is necessary to move the jumper JP7 (on the card PSDC14URPT) from position 1-2 to position 2-3, in this configuration the exciter will shut down at 20,5 V and power up again at 22,8 V.



**WARNING: If the exciter is used with mains power supply on ACCESSORY connector pins, dedicated to the entrance with battery, will be present a voltage of about 29Vcc.**

If you want to connect a buffer battery, you must connect a diode (dimensioned for a forward current of at least 15 A RMS) in series to the battery to avoid damaging both to the battery and the exciter.



**WARNING:** The exciter is internally protected from reversal of polarity on the battery input through the blade fuse like car type. The latter is mounted on the left side and accessible from outside.

Only when the voltage of mains power supply, instead of being at 230 Vac, was to values such to determine uncertainties in the operation of the machine (like in the case of lower voltage under 200 Vac), then it can be useful to move the switch from 230V to 115V position on the AC power supply card.



Figure 5.1: switch to change the voltage on the underside URPT / MIC

### 5.1.3 Connections

Connect the RF output of the transmitter to the antenna cable or a dummy load capable of dissipating amplifier output power. To begin with, set exciter to minimum output power and switch it off.



**WARNING: Electric shock hazard! Never handle the RF output connector when the equipment is powered on and no load is connected. Injury or death may result.**

Ensure that the POWER switch on the front panel is set to “OFF”. The exciter has a switch that interrupts completely the mains power of equipment.

Connect the mains power cable to the MAINS connector on the rear panel.





**Note:** the mains must be equipped with adequate earth connection properly connected to the equipment. This is a pre-requisite for ensuring operator safety and correct operation.

Alternatively, it is possible to supply the equipment through an external battery connected to the equipment via the ACCESSORY special connector on the rear panel.

Connect the audio (microphone and/or headphones) of their sources to the input connectors of the exciter placed on the front panel.

## 5.2 First power-on and setup

Follow the instructions below in case of first power-on or after a change in the configuration of the exciter in which this component is integrated.



**Note:** *Standard factory settings are RF output power off (**Pwr OFF**) and regulated output power set to upper limit (unless otherwise specified by customer).*

### 5.2.1 Power-on

When you have performed all of the connections described in the previous paragraph, power on the exciter using the suitable power switch on the front and rear panel.

### 5.2.2 Power check

Ensure that the **ON** LED turns on. Equipment name should appear briefly on the display, followed by forward power and modulation readings. If the RF output is disabled, those readings will be zero.

When the PLL locks to operating frequency, the LOCK LED will turn on.

### 5.2.3 How to enable the RF output

Check the state of the **Pwr** output power by the **Fnc** menu. If it is set to **OFF**, press **ENTER** to bring the selection to **ON**.



### 5.2.4 Level check of output power



**Note:** *The exciter incorporates Automatic Gain Control (AGC) and output power is modulated based on the power level set by the user and actual operating conditions, such as temperature, reflected power and other parameters. Please read Operation section for more details of RF power modulation.*

Access the **Power Setup Menu** pressing the following keys in the order:

**ESC** (opens **Default Menu**) ⇒ **ENTER** (hold down for 2 seconds)

Use the keys  and  in the **SET** menu to set exciter output power; the setting bar at the side of **SET** provides a graphic indication of power setting; please consider that the forward power readout provided on the display (**FWD: xxxx W**) reflects actual output power reading, **which may be lower than regulated power supply when Automatic Gain Control is running in power supply limitation mode** (please read Operation section about RF power supply modulation for more details).



**Note:** Output power may be set using the **Pwr OFF** control. In this condition, the output power readout (**Fwd**) on the display will read 0 (zero); the **SET** bar will reflect any adjustments you make using the keys and provides a graphic indication of how much power supply will be delivered the moment you return to **Pwr On** state. **ENTER** to bring the selection to **ON**.

### 5.3 Operation



NOTE: for simplification are shown below only screenshots of the typical version **URPT/MIC** (ver. microphone) able to reach 40W. The screenshots of **URPT/MIC** (ver. microphone) able to reach 20 or 30W are entirely identical with the difference of full scale values reachable from the equipment.

- 1) Power on the exciter and ensure that the **ON** light turns on. Equipment name should appear briefly on the display, quickly followed by modulation and forward power readings (Menu 1), provided that the exciter is delivering output power.



```

Mod: [|||||||||]  :
Fwd:      40    W
  
```

Menu 1

- 1b) To **modify power level setting**, hold down the **ENTER** button until opening the **power setup menu**.

The edit screen will look like this:





```

SET: [|||||||||]
Fwd:      40    W
  
```

Menu 2

Next to **SET** indication, a bar provides a graphic display of preset output power. The filled portion of the bar is proportional to set power level.

Example		
100% output power	Full bar	≈ 40W output (Depends on frequency)
50% output power	Half-full bar	≈ 20W output (Depends on frequency)
25% output power	Quarter-full bar	≈ 10W output (Depends on frequency)

The bottom line provides instantaneous power reading (40W for **URPT/MIC** shown here), press button  to increase level, press  to decrease it. When you have achieved the desired level, press **ENTER** to confirm and exit the **default menu**. Please note that the setting is stored automatically; in other words, if you press **ESC** or do not press any keys before the preset time times out, the latest power level set will be retained.



**NOTE:** This feature prevents the equipment from delivering maximum power as soon as output is enabled from menu 4, or in the event the equipment is already set to **ON** when you energise it.

- 2) Ensure that the equipment is not in a locked-out state. Press **ESC** to call up the selection screen (menu 3). Highlight **Fnc** and press **ENTER** to confirm and access the selected menu (menu 4).

If **PWR** is set to OFF, i.e. power output is disabled, move cursor to **PWR**. Press **ENTER** and label will switch to ON, i.e. power output is enabled.

Press **ESC** twice to go back to the default menu (menu 1).

- 3) Fine tune power setting from menu 2 (see description of item 1b) until achieving the desired value.
- 4) Check, again in the **Fnc** menu under **Tpy**, the set up on **Transm**; if it is set in **Repeat** position, please go with the cursor on that item. Press the **ENTER** key to change the voice under **Transm**.



**NOTE:** **Repeat** function is used in case you want an exciter in repeater mode together with a receiver, also if it is of other brands; if you select this mode, the pin 15 of ACCESSORY connector should be kept to GND to enable the delivery of output power. If you leave the pin 15 open, the output power is inhibited and into the main screen of display is written **StdBy** under **Fwd**.



**WARNING:** Equipment is capable of delivering more than rated output power of 40W; however, never exceed the specified power rating.

Next, you can review all operating parameters of the equipment through the management firmware.

Normally, the equipment can run unattended. Any alarm condition is handled automatically by the safety system or is signalled by the LED indicators on the panel or by display messages.



**NOTE:** Standard factory settings are output power set to upper limit (unless otherwise specified by customer) and **OFF**.

## 5.4 Management Firmware

The machine is provided with a two-line LCD display where a set of menus is shown. An overall view of the machine's menus is given in figure .

One of the following symbols may be present on the left side of the display, depending on the case:

- \_ (Cursor) - The cursor identifies the selected menu where you can have access.
- ▶ (Full arrow) - The parameter highlighted by the arrow can be modified. This symbol is present in menu composed of more than two lines as an help in the scroll menu.
- ▷▷▷ (Three empty arrows) - The parameter highlighted by the arrows is in phase of modification.
- ▷ (Empty Arrow) - The arrow points out the current line, the parameter of which cannot be modified. This symbol is present in the menu made up of more than two lines to help scroll the menu.



Figura 5.2

When the display is off, touching any key will turn on backlighting.

When the display is on, pressing the **ESC** button from the **default menu** (menu 1) calls up the **selection screen** (menu 3), which gives access to all other menus:

```

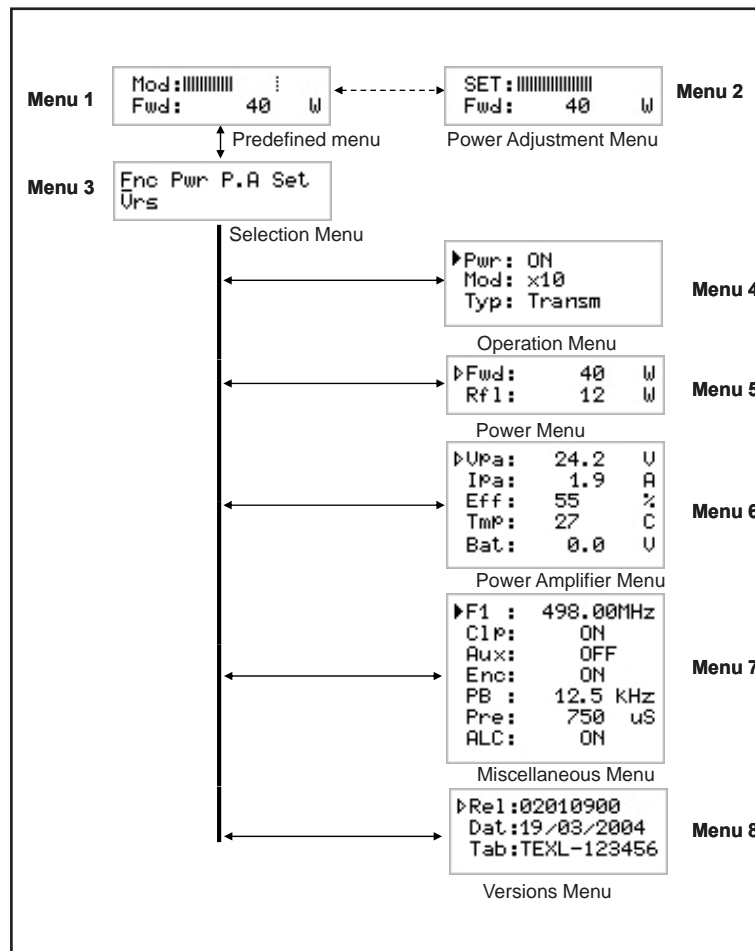
Fnc Pwr P.A Set
Urs
  
```

Menù 3

If the temperature alarm is enabled and the alarm threshold is exceeded, the following screen will be displayed (only if you are in the default screen):

```

!! ATTENTION !!
OVER TEMPERATURE
  
```

State 1





As soon as operating conditions are restored, power output is re-enabled with the same settings in use prior to the alarm condition.

To gain access to a submenu, select menu name (name is highlighted by cursor) using button  or  and press the **ENTER** button.

To return to the **default menu** (menu 1), simply press **ESC** again.

### 5.4.1 Operation Menu (Fnc)

In this menu, you can toggle exciter **power output** On/Off, set **deviation display mode** and **type of transmission (Transm)**.

To edit an item, highlight the appropriate line using the  and  buttons and then press and hold the **ENTER** button until the command is accepted. This way, Pwr setting is toggled between On and Off and Mod setting is toggled between “x1” and “x10”. To edit the Power Good rate, simply select item “PgD” or “PgR” and edit its value using the  and  buttons; finally, press **ENTER** to confirm.

```

▶ Pwr: ON
  Mod: x10
  Typ: Transm
  
```

*Menu 4*

- |     |  |
|-----|--|
| Pwr | Enables (ON) or disables (OFF) exciter power output.   |
| Mod | Modifies modulation display (toggles between “x1” and “x10”). In “x10” mode, instantaneous deviation indication is multiplied by a factor of 10, and the bar meter on the default menu will reflect 7.5 kHz instead of 75 kHz. This display mode is convenient when you wish to display low deviation levels, such as those caused by pilot tone or subcarriers. |
| Typ | Changes the use typology of the equipment, selectable between transmitter (TRANSM) or repeater (REPEAT).   |



**NOTE:** **Repeat** function is used in case you want an exciter in repeater mode together with a receiver, also if it is of other brands; if you select this mode, the pin 15 of ACCESSORY connector should be kept to GND to enable the delivery of output power. If you leave the pin 15 open, the output power is inhibited and into the main screen of display is written **StdBy** under **Fwd**.

## 5.4.2 Power menu (Pwr)

This screen holds all readings related to equipment output power:

▷Fwd:	40	W
Rfl:	12	W



Menu 5

Fwd Forward power reading.

Rfl Reflected power reading.

Note that these are readings, rather than settings, and cannot be edited (note the empty triangle). To change power setting, go to the **default menu** as outlined earlier.

## 5.4.3 Power Amplifier (P.A) Menu

This screen is made up of four lines that can be scrolled using the  and  buttons and shows the readings relating to final power stage:

▷Vpa:	24.2	V
Ipa:	1.9	A
Eff:	55	%
Tmp:	27	C
Bat:	0.0	V

Menu 6

Note that these are readings, rather than settings, and cannot be edited (note the empty arrow).

VPA Voltage supplied by amplifier module.

IPA Current draw of amplifier module.

Eff Efficiency based on ratio of forward power to amplifier module power, in percent ( FWD PWR/(Vpa x Ipa) % ).

Tmp Equipment internal temperature reading.

Bat Voltage supplied by external battery.



**NOTE:** it is normal that with mains power supplied in **Bat** there is a voltage of about 29 V, this is synonymous of the proper functioning of the mains power supply.

#### 5.4.4 Setup Menu (Set)

This menu lets you view and set operating frequency.

```

▶F1 : 498.00MHz
Clp:   ON
Aux:   OFF
Enc:   ON
PB : 12.5 KHz
Pre: 750 uS
ALC:   ON
  
```

*Menu 7*

- |     |  |
|-----|--|
| F1  | Operating frequency setup. Set a new frequency value and then press the <b>ENTER</b> button to confirm your selection; the exciter unlocks from current frequency (the <b>LOCK</b> LED turns off) and will lock to the new operating frequency ( <b>LOCK</b> turns back on again).<br>If you press <b>ESC</b> or let the preset time time out, the previous frequency setting is retained. |
| Clp | Enables (ON) or disables (OFF) the clipper.  |
| Aux | Enables (ON) or disables (OFF) the external audio, if present.   |
| Enc | Enables (ON) or disables (OFF) the sub-tone of control at 27 Hz.   |
| PB  | Adjusting of the frequency value of the low pass filter, expressed in kHz.   |
| Pre | Adjusting of the pre-emphasis value, expressed in $\mu$ S.   |
| ALC | Enables (ON) or disables (OFF) the automatic level control.  |



NOTE: Aux input, if enabled, disables the INP/4 XLR frontal connector and the audio is applied to pin 4 and 5 of ACCESSORY connector; the regulations related to this input are carried out with commands of INP/4 frontal input.



### 5.4.5 Version Menu (Vrs)

This screen holds equipment version/release information:

```
▶Rel :02010900  
Dat :19/03/2004  
Tab :TEXL-123456
```

*Menu 8*

Note that these are readings, rather than settings, and cannot be edited (note the empty arrow).

Rel	Firmware release information.
Dat	Release date.
Tab	Shows table loaded in the memory.

## 6. URPR/MIC quick guide for installation and use

This section provides a step-by-step description of equipment installation and configuration procedure. Follow these procedures closely upon first power-on and each time any change is made to general configuration, such as when a new receiver station is added or the equipment is replaced.

Once the desired configuration has been set up, no more settings are required for normal operation; at each power-up (even after an accidental shutdown), the equipment defaults to the parameters set during the initial configuration procedure.

The topics covered in this section are discussed at greater length in the next sections, with detailed descriptions of all hardware and firmware features and capabilities. Please see the relevant sections for additional details.



**IMPORTANT:** When configuring and testing the receiver in which the equipment is integrated, be sure to have the Final Test Table supplied with the equipment ready at hand throughout the whole procedure; the Final Test Table lists all operating parameters as set and tested at the factory.

### 6.1 Preapation

#### 6.1.1 Preliminary checks

Unpack the receiver and immediately inspect it for transport damage. Ensure that all connectors are in perfect condition.

Provide for the following (applicable to operating tests and putting into service):

- √ Single-phase 90÷250 VAC mains power supply, with adequate earth connection.
- √ Connection cable kit including:
  - Mains power cable or external power cable (i.e. battery via ACCESSORY connector).
  - RF cable for input from antenna (50 Ohm coaxial cable with N-type connector).
  - Audio cables between receiver and the devices that will use it, depending on the configuration of your installation.

## 6.1.2 Mains Power Supply



**WARNING: Disconnect mains power supply before beginning these procedures.**

The power supply unit is equipped with own fuses; **check all fuses and voltage selection block to ensure they are properly rated for the power mains and change them as required to match mains voltage.**

All mains power supply protection fuses are conveniently located on the rear panel and on left side, easily accessed from the outside: to check or replace a fuse, disconnect **equipment from power mains**, unscrew fuse cover and pull fuse out of socket.

The following fuses are used:

	<i>Main Fuses</i>
URPR/MIC (Mic. Version) <i>On DC Power Supply</i>	(1x) 3.15T 5x20 type
URPR/MIC (Mic. Version) <i>On fuse block</i>	(1x) 1A fast

Table 5.1: **Fuses**

Ensure that the equipment is appropriately set for available mains voltage (supply voltage rating is reported in the Final Test Table) as follows: **disconnect equipment from mains** and ensure that the voltage selection block of the power supply, located under the equipment, is set to the appropriate voltage; change setting as required.

The receiver, through the ACCESSORY connector, has an input for external power supply which accepts voltages from about 10,5 to 30 VDC. This source of auxiliary power supply, which can be used by the user through batteries, has a control that automatically turns off the power if the voltage falls too much and prevent irreparable damage: the receiver will turn off when the battery voltage reaches the 10,5 V and will switch on with 11,5 V (by factory).

If you want to use the battery at 24 V is necessary to move the jumper JP7 (on the card PSDC14URPT) from position 1-2 to position 2-3, in this configuration the exciter will shut down at 20,5 V and power up again at 22,8 V.



**WARNING: If the exciter is used with mains power supply on ACCESSORY connector pins, dedicated to the entrance with battery, will be present a voltage of about 29Vcc.**

If you want to connect a buffer battery, you must connect a diode (dimensioned for a forward current of at least 3 A RMS) in series to the battery to avoid damaging both to the battery and the exciter.



**WARNING:** *The receiver is internally protected from reversal of polarity on the battery input through the blade fuse like car type. The latter is mounted on the left side and accessible from outside.*

## 6.1.3 Connections

Connect the RF input of the receiver to the antenna cable. To begin with, switch it off.



**WARNING:** **Electric shock hazard! Never handle the RF input connector when the equipment is powered on and no load is connected. Injury or death may result.**

Ensure that the POWER switch on the front panel is set to “**OFF**”. The receiver has a switch that interrupts completely the mains power of equipment.

Connect the mains power cable to the MAINS connector on the rear panel.



**Note:** the mains must be equipped with adequate earth connection properly connected to the equipment. This is a pre-requisite for ensuring operator safety and correct operation.

Alternatively, it is possible to supply the equipment through an external battery connected to the equipment via the ACCESSORY special connector on the rear panel.

Finally, connect the audio output of the receiver to the devices that will use it, depending on the configuration of your installation.

## 6.2 First power-on and setup

Follow the instructions below in case of first power-on or after a change in the configuration of the receiver in which this component is integrated.



**Note:** Standard factory settings are AF audio off (**AF OFF**) and regulated mute set to upper limit (unless otherwise specified by customer).

### 6.2.1 Power-on

When you have performed all of the connections described in the previous paragraph, power on the receiver using the suitable power switch on the front and rear panel.



### 6.2.2 How to enable the AF output

Check the state of the **AF** output power by the **Fnc** menu. If it is set to **OFF**, press **ENTER** to bring the selection to **ON**.

### 6.2.3 Level check of muting

Access the **Power Setup Menu** pressing the following keys in the order:

**ESC** (opens **Default Menu**) ⇒ **ENTER** (hold down for 2 seconds)

Use the keys  and  in the **MUTE** menu to set receiver muting level. When the desired level is reached, press **ENTER** to confirm and exit to the predefined menu.



**Note:** the set value is stored anyway, so if you pass the time-out without pressing a key, the power will remain at the last set level.

### 6.3 Operation

- 1) Power on the receiver and ensure that the **ON** light turns on. Equipment name should appear briefly on the display, quickly followed by the graphic representation of the instantaneous modulation level and indication of received signal (menu 1).

The vertical bars under “Mod” indicate the progress of the modulation in real time; the hatched bar signals the maximum nominal modulation level at 75 kHz (100%).

The above line displays the instantaneous reading of the signal level received on analog scale.



Menu 1

- 1b) To **modify RF level setting**, hold down the **ENTER** button until opening the **power setup menu**.

The edit screen will look like this:

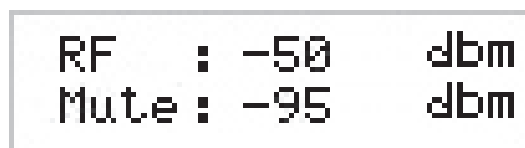

Menu 2

The upper line is a reading of RF level, while the bottom line gives the instantaneous reading of the muting level. Press button  $\downarrow \rightarrow$  to increase level, press  $\leftarrow \uparrow$  to decrease it. When you have achieved the desired level, press **ENTER** to confirm and exit the **default menu**. Please note that the setting is stored automatically; in other words, if you press **ESC** or do not press any keys before the preset time times out, the latest power level set will be retained.

- 2) Ensure that the equipment is not in a locked-out state. Press **ESC** to call up the selection screen (menu 3). Highlight **Fnc** and press **ENTER** to confirm and access the selected menu (menu 4).

If **AF** is set to OFF, move cursor to **AF**. Press **ENTER** and label will switch to ON.

Press **ESC** twice to go back to the default menu (menu 1).

- 3) Fine tune mute setting from menu 2 (see description of item 1b) until achieving the desired value.
- 4) Check, again in the **Fnc** menu under **Tpy**, the set up on **Transm**; if it is set in **Repeat** position, please go with the cursor on that item. Press the **ENTER** key to change the voice under **Transm**.



**NOTE: Repeat** function is used in case you want an receiver in repeater mode together with a exciter, also if it is of other brands; if you select this mode, the pin 15 of ACCESSORY connector should be kept to GND to enable the delivery of output power. If you leave the pin 15 open, the output power is inhibited and into the main screen of display is written **StdBy** under **Fwd**.

Next, you can review all operating parameters of the equipment through the management firmware.

Normally, the equipment can run unattended. Any alarm condition is handled automatically by the safety system or is signalled by the LED indicators on the panel or by display messages.



**NOTE:** Standard factory settings are output power set to upper limit (unless otherwise specified by customer) and **OFF**.

## 6.4 Management Firmware

The machine is provided with a two-line LCD display where a set of menus is shown. An overall view of the machine's menus is given in figure .

One of the following symbols may be present on the left side of the display, depending on the case:

- \_ (Cursor) - The cursor indentifies the selected menu where you can have access.
- ▶ (Full arrow) - The parameter highlighted by the arrow can be modified. This symbol is present in menu composed of more than two lines as an help in the scroll menu.
- ▶▶▶ (Three empty arrows) - The parameter highlighted by the arrows is in phase of modification.
- ▷ (Empty Arrow) - The arrow points out the current line, the parameter of which cannot be modified. This symbol is present in the menus made up of more than two lines to help scroll the menu.

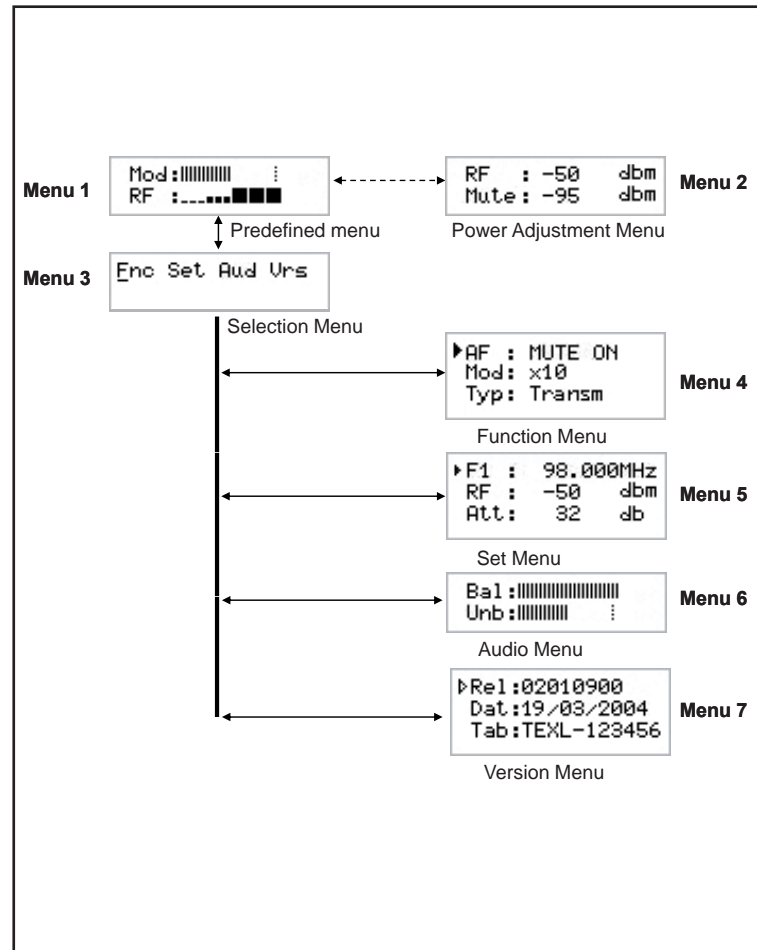
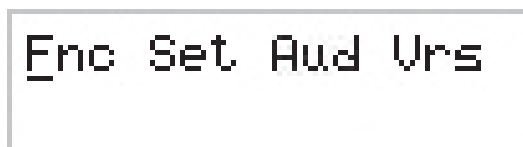

Figure 6.1

When the display is off, touching any key will turn on backlighting.

When the display is on, pressing the **ESC** button from the **default menu** (menu 1) calls up the **selection screen** (menu 3), which gives access to all other menus:



Menù 3





To gain access to a submenu, select menu name (name is highlighted by cursor) using button  $\downarrow$  or  $\leftarrow$  and press the **ENTER** button.

To return to the **default menu** (menu 1), simply press **ESC** again.



### 6.4.1 Function Menu (Fnc)

In this menu, you can toggle receiver **muting** On/Off, set **deviation display mode** and **type of transmission (Transm)**.

To edit an item, highlight the appropriate line using the  and  buttons and then press and hold the **ENTER** button until the command is accepted. This way, Pwr setting is toggled between On and Off and Mod setting is toggled between “x1” and “x10”. To edit the Power Good rate, simply select item “PgD” or “PgR” and edit its value using the  and  buttons; finally, press **ENTER** to confirm.

```
▶ AF : MUTE ON
Mod : x10
Typ : Transm
```

*Menu 4*

- AF            Enables (ON) or disables (OFF) receiver muting.
- Mod         Modifies modulation display (toggles between “x1” and “x10”). In “x10” mode, instantaneous deviation indication is multiplied by a factor of 10, and the bar meter on the default menu will reflect 7.5 kHz instead of 75 kHz. This display mode is convenient when you wish to display low deviation levels, such as those caused by pilot tone or subcarriers.
- Typ         Changes the use typology of the equipment, selectable between transmitter (TRANSM) or repeater (REPEAT).



**NOTE: Repeat** function is used in case you want an exciter in repeater mode together with a receiver, also if it is of other brands; if you select this mode, the pin 15 of ACCESSORY connector should be kept to GND to enable the delivery of output power. If you leave the pin 15 open, the output power is inhibited.



#### 6.4.4 Version Menu (Vrs)

This screen holds equipment version/release information:

```
▶Re1:02010900  
Dat:19/03/2004  
Tab:TEXL-123456
```

*Menu 7*

Note that these are readings, rather than settings, and cannot be edited (note the empty arrow).

Re1	Firmware release information.
Dat	Release date.
Tab	Shows table loaded in the memory.

## 7. Identification and Access to the Modules

The **URPT/MIC** and **URPR/MIC** (microphonic version) are made up of various modules linked to each other through connectors so as to make maintenance and any required module replacement easier.

### 7.1 URPT MIC Upper View

The figure below shows the equipment upper view with the various components pointed out.

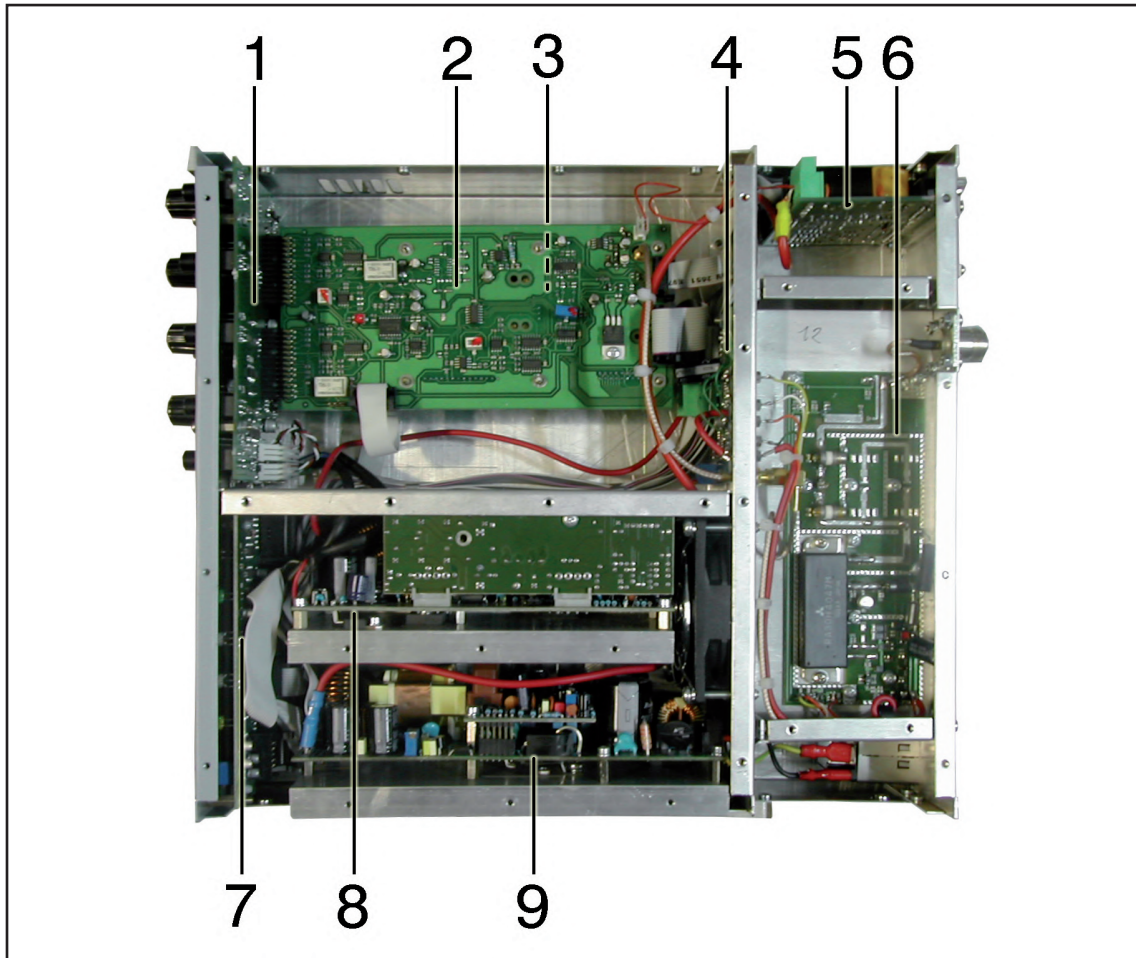

Figure 7.1

- [1] Panel Card
- [2] Microfonic Audio Card
- [3] FET motherboard or SKY motherboard
- [4] RF Control Card
- [5] Connection Interface Card
- [6] Power Amplifier Card
- [7] Blue Panel Card
- [8] AC Power Supply
- [9] DC Power Supply

## 7.2 URPT MIC Upper View

The figure below shows the equipment upper view with the various components pointed out.

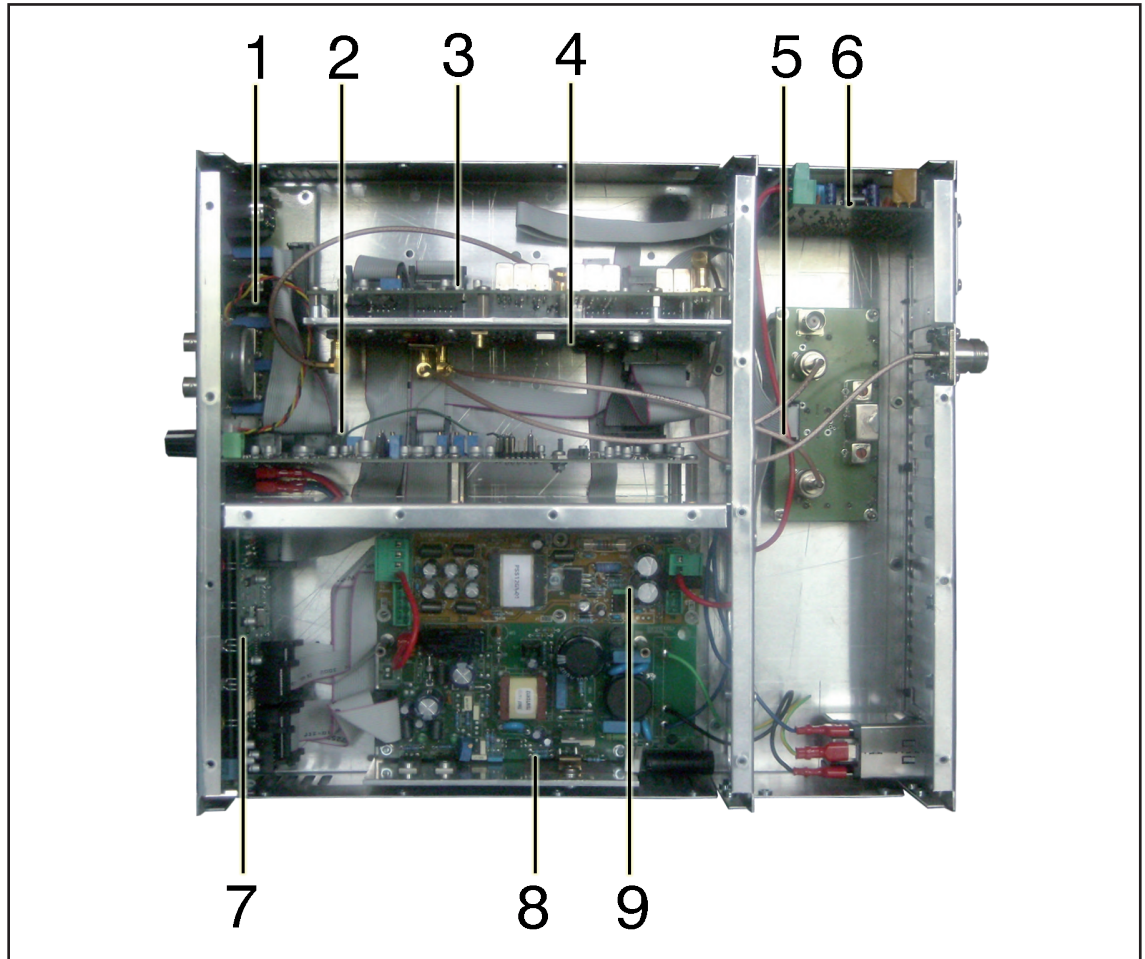

Figure 7.2

- [1] Panel Card
- [2] 70MHz IF Audio Card
- [3] Front-End and VCO Card
- [4] IF NARROW-B Converter Card
- [5] 10.7 MHz Band Pass Filter Card
- [6] Connection Interface Card
- [7] Blue Panel Card
- [8] AC Power Supply
- [9] DC Power Supply

*This page was intentionally left blank*





**R.V.R. Elettronica S.p.A.**

Via del Fonditore, 2 / 2c  
Zona Industriale Roveri · 40138 Bologna · Italy  
Phone: +39 051 6010506 · Fax: +39 051 6011104  
e-mail: [info@rvr.it](mailto:info@rvr.it) · web: <http://www.rvr.it>

ISO 9001:2000 certified since 2000



The RVR Logo, and others referenced RVR products and services are trademarks of RVR Elettronica S.p.A. in Italy, other countries or both. RVR ® 1998 all rights reserved.  
All other trademarks, trade names or logos used are property of their respective owners.