



TX05KSS/61D082B & TX05KSS/61S082

USER MANUAL



File Name: TX05KSS_61D082B-61S082_ING_1.0.indb

Version: 1.0

Date: 28/11/2016

Revision History

Date	Version	Reason	Editor
28/11/2016	1.0	First Version	J. H. Berti

TX05KSS/61D082B & TX05KSS/61S082 - User Manual
Version 1.0

© Copyright 2016
R.V.R. Elettronica SpA
Via del Fonditore 2/2c - 40138 - Bologna (Italia)
Telefono: +39 051 6010506
Fax: +39 051 6011104
Email: info@rvr.it
Web: www.rvr.it

All rights reserved
Printed and bound in Italy. No part of this manual may be reproduced, memorized or transmitted in any form or by any means, electronic or mechanic, including photocopying, recording or by any information storage and retrieval system, without written permission of the copyright owner.

Notification of intended purpose and limitations of product use

This product is a FM transmitter intended for FM audio broadcasting. It utilises operating frequencies not harmonised in the intended countries of use.

The user must obtain a license before using the product in intended country of use. Ensure respective country licensing requirements are complied with.

Limitations of use can apply in respect of operating frequency, transmitter power and/or channel spacing.

Declaration of Conformity

Hereby, R.V.R. Elettronica SpA, declares that this FM transmitter is in compliance with the essential requirements and other relevant provisions of Directive 1999/5/EC.





DECLARATION OF CONFORMITY

We, the undersigned,

Manufacturer's Name: **R.V.R. Elettronica SpA**
Manufacturer's Address: **Via del Fonditore 2/2c
I - 40138 Bologna
Italy**

Certify and declare under our sole responsibility that the product:

Product Description: **FM Solid State Transmitter Station for radio broadcasting**
Model: **AFM-PTD2PJG2B**
Composed: **1- PJ2500LCD (2x Amp.) & PTX150DDS (Exciter)**
Variants: **2- PJ2500LCD (2x Amp.) & PTX100DDS (Exciter)**
Frequency Range: **87.5 ÷ 108.0 MHz**
RF Power Output: **500 ÷ 5000W**

when used for its intended purpose, is in compliance with the essential requirements and other relevant provisions of Directive 99/5/CE "R&TTE", and therefore carries the "CE" mark.

The conformity assessment procedure referred in Article 10 and detailed in Annex III of Directive 99/5/EC has been followed.

The following harmonized standard have been applied:

Radio (3.2): ETSI EN 302 018-1 V1.2.1 (2006-03) +
ETSI EN 302 018-2 V1.2.1 (2006-03)
EMC (3.1b): ETSI EN 301 489-1 V1.9.1 (2011-04) +
ETSI EN 301 489-11 V1.3.1 (2006-05)
Safety (3.1a): EN 60215 (1997-10)

The technical documentation is held at the location above, as required by the conformity assessment procedure.

Bologna, Italy, 26/05/2011

Ravagnani Stefano
Technical Manager
R.V.R Elettronica S.p.A.

Technical Specification

		TX05KSS/61S082	TX05KSS/61D082B
GENERALS	Conditions	U.M.	Value
Frequency range		MHz	87.5 + 108
Rated output power		W	5000
Modulation Type			Direct Digital Synthesis
Operational Mode			Mono, Stereo, Multiplex
Ambient Working temperature		°C	-10 to + 50
Frequency programmability			By software with 1, 10, 100, 1000 kHz steps
Frequency stability	WT from -10°C to 50°C	ppm	±1
Modulation capability		KHz	150
Pre-emphasis mode		µS	0, 50 (CCIR), 75 (FCC)
Spurious & harmonic suppression		dBc	< -80 (85 typical)
Asynchronous AM S/N ratio	Referred to 100% AM, with no de-emphasis	dB	≥ 60 (65 typical)
Synchronous AM S/N ratio	Referred to 100% AM, FM deviation 75 kHz by 400Hz sine, without de-emphasis	dB	≥ 50 (55 typical)
MONO OPERATION			
S/N FM Ratio	RMS @ ± 75 kHz peak, HPF 20Hz - LPF 23 kHz, 50 µS de-emphasis	dB	> 80 (typical 83)
	Opk @ ± 75 kHz peak, CCR weighted, 50 µS de-emphasis	dB	> 76
	Opk @ ± 40 kHz peak, CCR weighted, 50 µS de-emphasis	dB	> 70
Frequency Response	30Hz + 15kHz	dB	better than ± 0.5 dB (typical ± 0.2)
Total Harmonic Distortion	THD+N 30Hz + 15kHz	%	< 0.05 (Typical 0.03%)
Intermodulation Distortion	Measured with a 1 KHz, 1:3 kHz tones, 1:1ratio, @ 75 kHz FM	%	< 0.02
Transient Intermodulation distortion	3.18 kHz square wave, 15 kHz sine wave @ 75 kHz FM	%	< 0.1 (typical 0.05)
MPX OPERATION			
Composite S/N FM Ratio	RMS @ ± 75 kHz peak, HPF 20Hz - LPF 23 kHz, 50 µS de-emphasis	dB	> 75 (typical 79)
Frequency Response	30Hz + 53kHz	dB	± 0.2
	53kHz + 100kHz	dB	± 0.5
Total Harmonic Distortion	THD+N 30Hz + 53kHz	%	< 0.05
Intermodulation distortion	THD+N 53kHz + 100kHz	%	< 0.1
	Measured with a 1 KHz, 1:3 kHz tones, 1:1ratio, @ 75 kHz FM	%	< 0.05
Transient Intermodulation distortion	3.18 kHz square wave, 15 kHz sine wave @ 75 kHz FM	%	< 0.1 (typical 0.05)
Stereo separation	30Hz + 53kHz	dB	> 70 dB
STEREO OPERATION			
Stereo S/N FM Ratio	RMS @ ± 75 kHz peak, HPF 20Hz - LPF 23 kHz, 50 µS de-emphasis, L & R demodulated	dB	> 80 (Typical 83)
	Opk @ ± 75 kHz peak, CCR weighted, 50 µS de-emphasis, L & R demodulated	dB	> 70 (Typical 73)
	Opk @ ± 40 kHz peak, CCR weighted, 50 µS de-emphasis, L & R demodulated	dB	> 68 (Typical 70)
Frequency Response	30Hz + 15kHz	dB	± 0.2
Total Harmonic Distortion	THD+N 30Hz + 15kHz	%	< 0.03
Intermodulation distortion	Measured with a 1 KHz, 1:3 kHz tones, 1:1ratio, @ 75 kHz FM	%	< 0.02
Transient Intermodulation distortion	3.18 kHz square wave, 15 kHz sine wave @ 75 kHz FM	%	< 0.1 (typical 0.05)
Stereo separation		dB	> 70
Main / Sub Ratio	30Hz + 15kHz	dB	> 45 (typical 50)
SCA OPERATION			
Frequency response	40kHz + 100kHz	dB	± 0.5
Crosstalk to main or to stereo channel	RMS, ref @ ± 75 kHz peak, no HPF/LPF, 0µS de-emphasis, with 67 kHz tone on SCA input @ 7.5kHz FM deviation	dB	> 75 (typical 79)
	RMS, ref @ ± 75 kHz peak, no HPF/LPF, 0µS de-emphasis, with 92 kHz tone on SCA input @ 7.5kHz FM deviation	dB	> 80 (typical 81)
POWER REQUIREMENTS			
Power supply type	AC Supply Voltage	VAC	Mono Phase / Threephase
AC Power Input	AC Apparent Power Consumption	VA	7641 230 ±15% / 400 ±15%
	Active Power Consumption	W	7467 8126
	Overall efficiency	%	> 60 (Typical 66)
	Power Factor		0.97
	Connector		Terminal Block L+N+PE / RST+N+PE
VARIOUS			
Cooling			Forced, with internal fan
Acoustic Noise		dBA	< 75
AUDIO INPUTS			
Left	Connector		XLR F
	Type		Balanced
	Impedance	Ohm	10 k or 600
Right	Input Level, Adjustment Range	dBu	-12.5 to +12.5
	Connector		XLR F
	Type		Balanced
MPX	Impedance	Ohm	10 k or 600
	Input Level, Adjustment Range	dBu	-12.5 to +12.5
	Connector		BNC
SCARDS	Type		unbalanced
	Impedance	Ohm	10 k
	Input Level, Adjustment Range	dBu	-30 to +13
AES/EBU	Connector		XLR F
	Type		Balanced
TOSLink	Impedance	Ohm	110
	Connector		TOS Link
OPTUTS	Impedance	Ohm	Optical
	Connector		
RF Output	Connector		7/8" EIA type
	Impedance	Ohm	50
RF Monitor	Connector		BNC
	Impedance	Ohm	50
	Output Level	dBc	approx. -40
Pilot output	Connector		BNC
	Impedance	Ohm	> 600
	Output Level	Vpp	2.2
MPX Monitor	Output Level, Adjustment Range	dBu	-12.5 to +5; or -6.5 to +11 (internal jumper to increase the output level of +6dBu); or -0.5 to 17 (internal jumper to increase the output level of +12dBu)
	Connector		BNC
	Impedance	Ohm	> 600
MPX Monitor	Output Level	Vpp	-12.5 to +5; or -6.5 to +11 (internally adjustable +6dBu by jumper); or -0.5 to 17 (internally adjustable +12dBu by jumper)

Table of Contents

1. Preliminary Instructions	1
2. Warranty	1
3. First Aid	2
3.1 Electric shock treatment	2
3.2 Treatment of electric burns	2
4. General Description	3
4.1 Composition	3
5. Installation and Use	5
5.1 Installation	5
5.2 First Start	9
6. First Operations	17
6.1 Exciter (PTX DDS)	17
6.2 Amplifier (PJ LCD)	19
6.3 Changeover (SCML1+1SL)	19

This page was intentionally left blank

IMPORTANT



The symbol of lightning inside a triangle placed on the product, evidences the operations for which is necessary gave it full attention to avoid risk of electric shocks.



The symbol of exclamation mark inside a triangle placed on the product, informs the user about the presence of instructions inside the manual that accompanies the equipment, important for the efficacy and the maintenance (repairs).

1. Preliminary Instructions

• General Warnings

This equipment should only be operated, installed and maintained by "trained" or "qualified" personnel who are familiar with risks involved in working on electric and electronic circuits. "Trained" means personnel who have technical knowledge of equipment operation and who are responsible for their own safety and that of other unqualified personnel placed under their supervision when working on the equipment. "Qualified" means personnel who are trained in and experienced with equipment operation and who are responsible for their own safety and that of other unqualified personnel placed under their supervision when working on the equipment.

 **WARNING: Residual voltage may be present inside the equipment even when the ON/OFF switch is set to Off. Before servicing the equipment, disconnect the power cord or switch off the main power panel and make sure the safety earth connection is connected. Some service situations may require inspecting the equipment with live circuits. Only trained and qualified personnel may work on the equipment live and shall be assisted by a trained person who shall keep ready to disconnect power supply at need.**

R.V.R. Elettronica S.p.A. shall not be liable for injury to persons or damage to property resulting from improper use or operation by trained/untrained and qualified/unqualified persons.

 **WARNING: The equipment is not water resistant. Any water entering the enclosure might impair proper operation. To prevent the risk of electrical shock or fire, do not expose this equipment to rain, dripping or moisture.**

Please observe local codes and fire prevention rules when installing and operating this equipment.

 **WARNING: This equipment contains exposed live parts involving an electrical shock hazard. Always disconnect power supply before removing any covers or other parts of the equipment.**

Ventilation slits and holes are provided to ensure reliable operation and prevent overheating; do not obstruct or cover these slits. Do not obstruct the ventilation slits under any circumstances. The product must not be incorporated in a rack unless adequate ventilation is provided or the manufacturer's instructions are followed closely.

 **WARNING: This equipment can radiate radiofrequency energy and, if not installed in compliance with manual instructions and applicable regulations, may cause interference with radio communications.**

 **WARNING: This equipment is fitted with earth connections both in the power cord and for the chassis. Make sure both are properly connected.**

Operation of this equipment in a residential area may cause radio interference, in which case the user may be required to take adequate measures.

The specifications and data contained herein are provided for information only and are subject to changes without prior notice. R.V.R. Elettronica S.p.A. disclaims all warranties, express or implied. While R.V.R. Elettronica S.p.A. attempts to provide accurate information, it cannot accept responsibility or liability for any errors or inaccuracies in this manual, including the products and the software described herein. R.V.R. Elettronica S.p.A. reserves the right to make changes to equipment design and/or specifications and to this manual at any time without prior notice.

• Notice concerning product intended purpose and use limitations.

This product is a radio transmitter suitable for frequency-modulation audio radio broadcasting. Its operating frequencies are not harmonised in designated user countries. Before operating this equipment, user must obtain a licence to use radio spectrum from the competent authority in the designated user country. Operating frequency, transmitter power and other characteristics of the transmission system are subject to restrictions as specified in the licence.

2. Warranty

La R.V.R. Elettronica S.p.A. warrants this product to be free from defects in workmanship and its proper operation subject to the limitations set forth in the supplied Terms and Conditions. Please read the Terms and Conditions carefully, as purchase of the product or acceptance of the order acknowledgement imply acceptance of the Terms and Conditions. For the latest updated terms and conditions, please visit our web site at WWW.RVR.IT. The web site may be modified, removed or updated for any reason whatsoever without prior notice. The warranty will become null and void in the event the product enclosure is opened, the product is physically damaged, is repaired by unauthorised persons or is used for purposes other than its intended use, as well as in the event of improper use, unauthorised changes or neglect. In the event a defect is found, follow this procedure:

- 1 Contact the seller or distributor who sold the equipment; provide a description of the problem or malfunction for the event a quick fix is available.

Sellers and Distributors can provide the necessary information to troubleshoot the most frequently encountered problems. Normally, Sellers and Distributors can offer a faster repair service than the Manufacturer would. Please note that Sellers can pinpoint problems due to wrong installation.

- 2 If your Seller cannot help you, contact R.V.R. Elettronica S.p.A. and describe the problem; if our staff deems it appropriate, you will receive an authorisation to return the equipment along with suitable instructions;
- 3 When you have received the authorisation, you may return the unit. Pack the unit carefully before shipment; use the original packaging whenever possible and seal the package perfectly. The customer bears all risks of loss (i.e., R.V.R. shall not be liable for loss or damage) until the package reaches the R.V.R. factory. For this reason, we recommend insuring the goods for their full value. Returns must be sent on a C.I.F. basis (PREPAID) to the address stated on the authorisation as specified by the R.V.R. Service Manager.



Units returned without a return authorisation may be rejected and sent back to the sender.

- Be sure to include a detailed report mentioning all problems you have found and copy of your original invoice (to show when the warranty period began) with the shipment.

Please send spare and warranty replacement parts orders to the address provided below. Make sure to specify equipment model and serial number, as well as part description and quantity.



R.V.R. Elettronica S.p.A.
Via del Fonditore, 2/2c
40138 BOLOGNA ITALY
Tel. +39 051 6010506

3. First Aid

All personnel engaged in equipment installation, operation and maintenance must be familiar with first aid procedures and routines.

3.1 Electric shock treatment

3.1.1 If the victim is unconscious

Follow the first aid procedures outlined below.

- Lay the victim down on his/her back on a firm surface.
- the neck and tilt the head backwards to free the airway system (**Figure 1**).

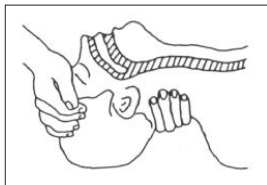

Figure 1

- If needed, open the victim's mouth and check for breathing.
- If there is no breathing, start artificial respiration without delay (**Figure 2**) as follows: tilt the head backwards, pinch the nostrils, seal your mouth around the victim's mouth and give four fast rescue breaths.



Figure 2

- Check for heartbeat (**Figure 3**); if there is no heartbeat, begin chest compressions immediately (**Figure 4**) placing your hands in the centre of the victim's chest (**Figure 5**).

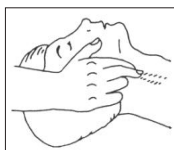

Figure 3

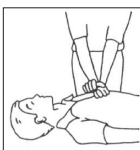

Figure 4

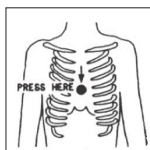

Figure 5

- One rescuer: give 2 quick rescue breaths after each 15 compressions.
- Two rescuers: one rescue breath after each 5 compressions.
- Do not stop chest compressions while giving artificial breathing.
- Call for medical help as soon as possible.

3.1.2 If the victim is conscious

- Cover victim with a blanket.
- Try to reassure the victim.
- Loosen the victim's clothing and have him/her lie down.
- Call for medical help as soon as possible.

3.2 Treatment of electric burns

3.2.1 Large burns and broken skin

- Cover affected area with a clean cloth or linen.
- Do not break any blisters that have formed; remove any clothing or fabric that is stuck to the skin; apply adequate ointment.
- Administer adequate treatment for the type of accident.
- Get the victim to a hospital as quickly as possible.
- Elevate arms and legs if injured.

If medical help is not available within an hour, the victim is conscious and is not retching, administer a solution of table salt and baking soda (one teaspoon of table salt to half teaspoon of baking soda every 250 ml of water).

Have the victim slowly drink half a glass of solution for four times during a period of 15 minutes.

Stop at the first sign of retching.

Do not administer alcoholic beverages.

3.2.2 Minor burns

- Apply cold (not ice cold) strips of gauze or dress wound with clean cloth.
- Do not break any blisters that have formed; remove any clothing or fabric that is stuck to the skin; apply adequate ointment.
- If needed, have the victim change into clean, dry clothing.
- Administer adequate treatment for the type of accident.
- Get the victim to a hospital as quickly as possible.
- Elevate arms and legs if injured.

4. General Description

The **TX05KSS/61D082B** and **TX05KSS/61S082** are RF transmitters for frequency modulation sound broadcasting. They are fully solid-state apparatus of modern design that uses LD-MOSFET as active components in the FM amplifying modules.

The overall efficiency is better than 70% across the bandwidth, for this reason are part of RVR Green Line family.

This performance characteristic is guaranteed in a range between +0.25 dB and -3 dB (+5% and -50%) referred to the nominal power of the equipment; outside these limits the equipment is able to work properly but can not guarantee an efficiency of 70%.

This chapter briefly describes the machine's main features

4.1 Composition

The **TX05KSS/61D082B** is made up:

- 2 **PTX100DDS** exciter
- 1 **SCML1+1SL/V2** changeover
- 1 **HC2-5GRL** hybrid coupler
- 2 **PJ2500LCD** amplifier

The standard configuration of the **TX05KSS/61D082B** foresees one 19" 27HE rack (see figure below). The manufacturer will produce upon customers request special configurations.

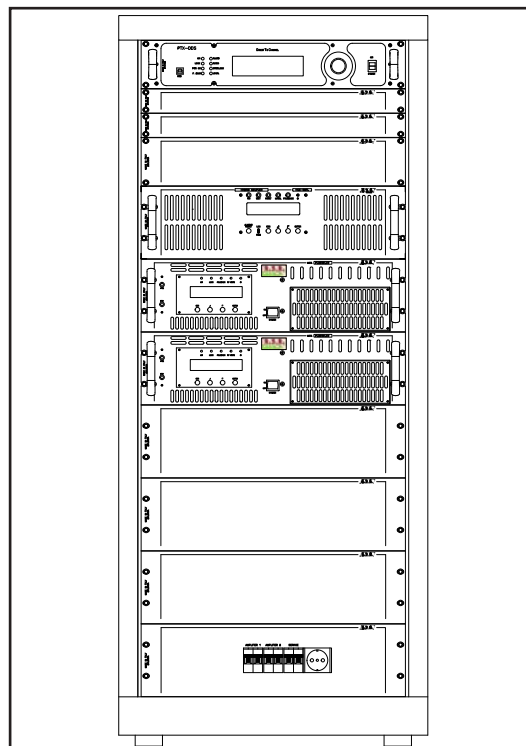

The **TX05KSS/61S082** is made up:

- 1 **PTXDDS** exciter
- 1 **HC2-5GRL** hybrid coupler
- 2 **PJ2500LCD** amplifier

The standard configuration of the **TX05KSS/61S082** foresees one 19" 27HE rack (see figure below). The manufacturer will produce upon customers request special configurations.

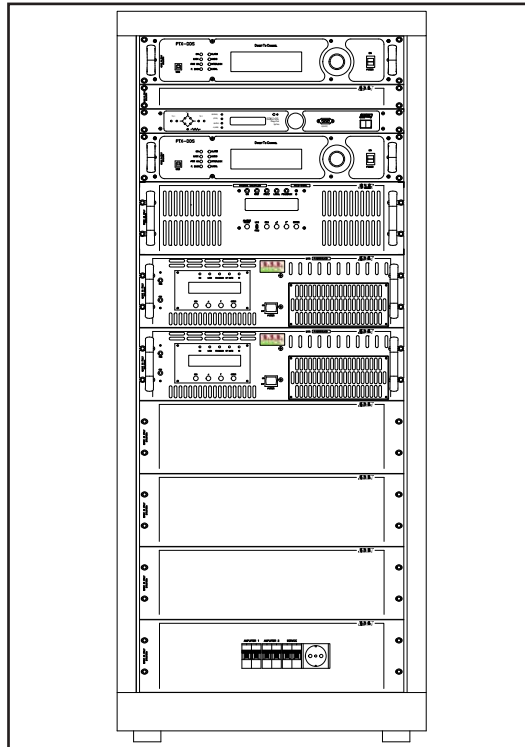

Note: This manual gives system-level information about the **TX05KSS/61D082B** and **TX05KSS/61S082**. Further details about the operation of the single components please refer to the relative manuals, that are attached to the present one and should be considered a part of it.

5. Installation and Use

This chapter contains the basic instructions for installing and using both the **TX05KSS/61D082B** and the **TX05KSS/61S082**. If necessary, more depth information about the operating principles may be found in the components' manuals.

5.1 Installation

For practical reasons and for transport safety, the machine can be supplied disassembled to the customer. The assembly procedure is rather simple and can be carried out by any qualified technician.



Note: In order to avoid the risk of damaging the machine and/or of injuring the operators, it is advisable to closely adhere to the instructions provided below. always respect all the safety regulations and standards in force.

Unpack the transmitter and before any other operation check that the equipments hasn't been damaged during transport and all the controls and connectors on the front and rear panels are in good condition.

To install both the **TX05KSS/61D082B** and the **TX05KSS/61S082** transmitter please refer to the relative technical dossier, particularly about:

- Mains supply connection
- RF connections
- Audio connections

Perform the connections following the instructions and schematics given in the station's documentation (technical dossier).

Install the rack in the point in which the transmitter will be put in operation. The rack is mounted on wheels for easy movement so that, once placed in the desired location, it is advisable to use the four screws located at the base of the rack to stabilize it perpendicularly to ground.



The transmitter normally have the outlet air iin the back of machine.

In this case, provide adequate ventilation of the room.

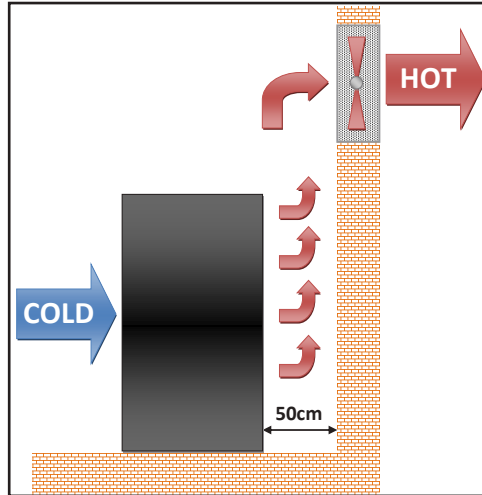

In alternative is cooled by forced ventilation and the air outlet is located on the roof of machine. Is recommended a length of tube approximatively of 1,5 meter.

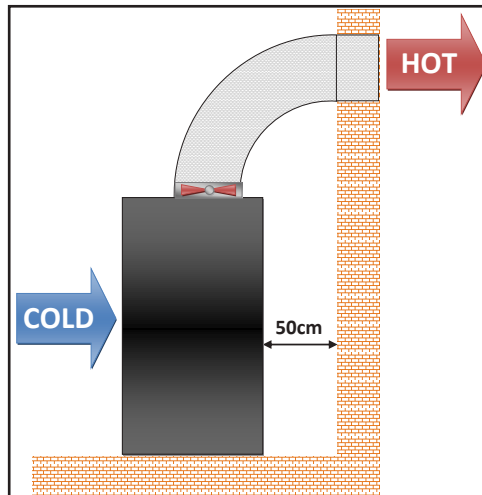

Is highly recommended to install the rack at least 50 cm from the rear and side wall so as to allow an optimum air flow and to facilitate workers.

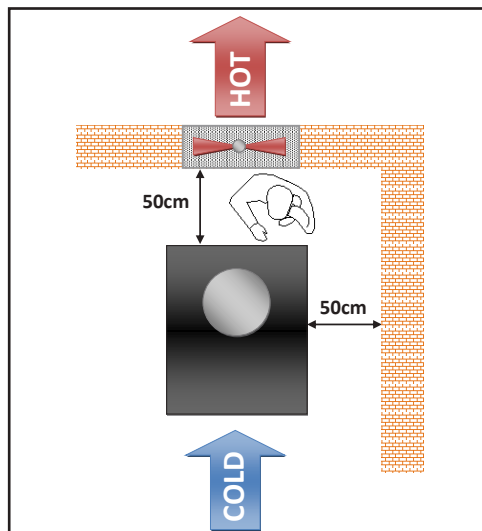

Connect the overall power cord of machine. The cable can be slid through the cable gland located on the back, or on the roof, of the machine and conductors must be attached to the general disconnecting switch terminals.



Note: The connection of machine to power supply is done by fixing a multi-pole cable with exposed terminals to a terminal board. Make sure, with no possibility of error, that the cable is not under tension when you connect it to the machine.



WARNING: Is highly recommended to don't turn on the machine without first having connected the RF output to antenna or dummy load!

If you have a dummy load capable to dissipate the RF power generated by the transmitter, it is advisable to carry out first tests by linking to it rather than to the transmission antenna.

If transmitter require a single-phase power with F (black or brown or grey) + N (blue) + GND (green yellow), keep in mind this requirement to connect to your distribution board.

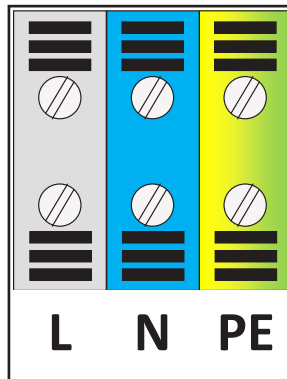

If transmitter require three-phase power with 3F (black, brown and grey) + N (blue) + GND (green yellow), keep in mind this requirement to connect to your distribution board.

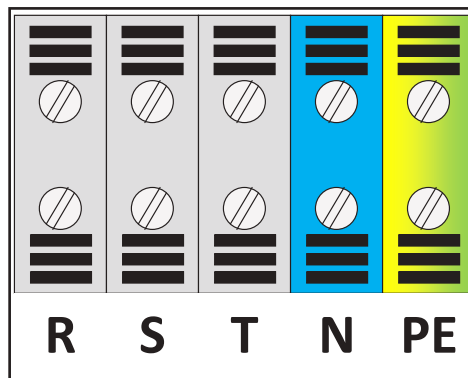

Note: the mains must be equipped with adequate earth connection properly connected to the equipment. This is a pre-requisite for ensuring operator safety and correct operation.

The following table shows the recommended cable cross-sections:

CONNECTOR	THREE-PHASE CABLE SECTION	SINGLE-PHASE CABLE SECTION
L		∅
R	∅	
S	∅	
T	∅	
N	∅	∅
PE	∅	∅

Typically the distribution board contains the thermal-magnetic circuit breakers for each amplifier included in the system and one for service.

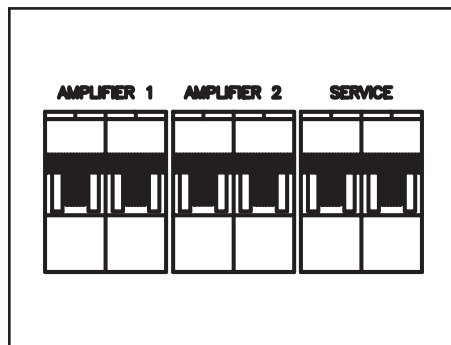

WARNING: Electric shock hazard! Never handle the RF output connector when the equipment is powered on and no load is connected. Injury or death may result.

Ensure that the distribution board of the transmitter is set to “OFF”.

Connect the RF output of the transmitter to the antenna cable or a dummy load capable of dissipating amplifier output power.

Connect the audio and RDS/SCA signals from user’s sources to the transmitter input connectors.

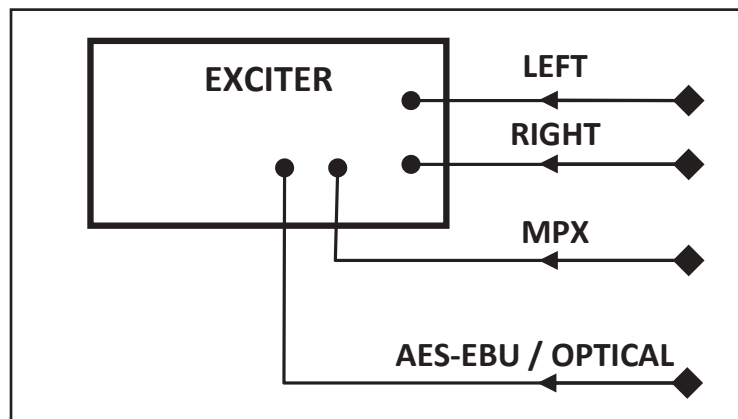

Audio connections of a system in single exciter configuration

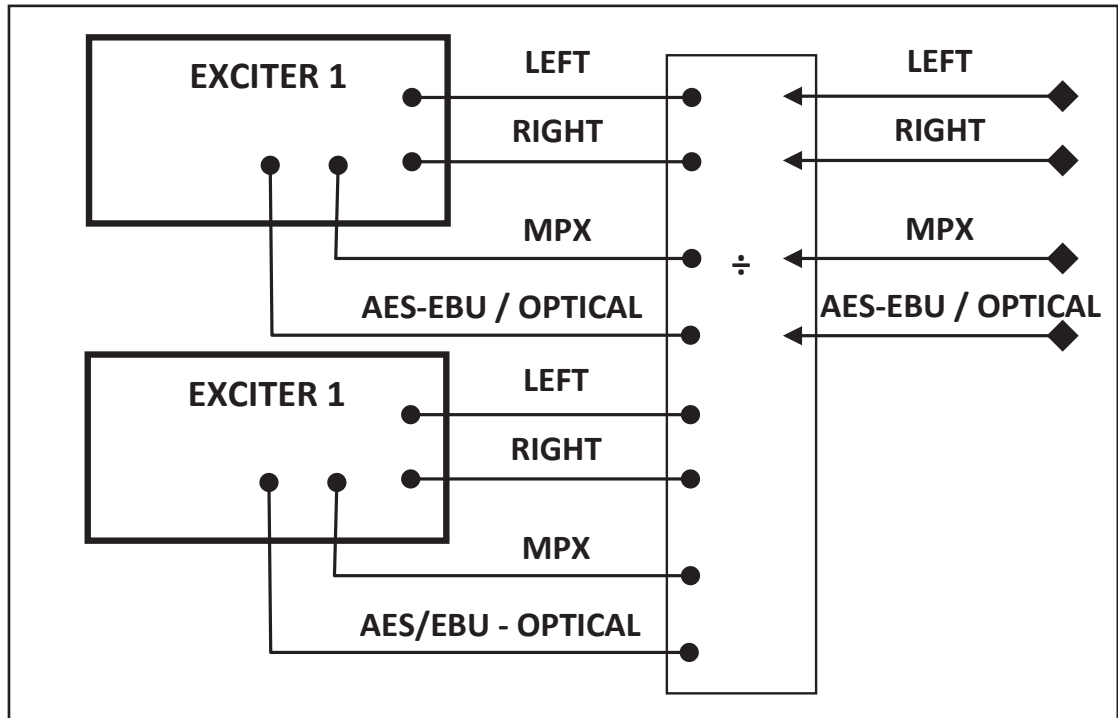

Audio connections of a system in double exciter configuration



Note: In dual exciter configuration is necessary to insert an audio splitter (not included by default).

In case you use a passive splitter is necessary to calibrate all audio levels in order to obtain the correct deviation.

5.2 First Start

This section describes the procedure for powering-on the machine the first time.

For a description of the power up procedure of the single amplifiers in the different cases, of the use of the exciters and of the hybrid combiner, please consult the relative manuals.

5.2.1 Preliminary Operations

Before activating the apparatus, please perform the necessary connections, that is:

- Power supply
- Modulating signals
- RF loads

It is advisable to run the first tests connecting the transmitter to a suitable (for type and power) dummy load rather than to the transmission antenna.



Note: during the RF output power rising, check the reflected power level (on amplifier) to verify the antenna status.

The transmitter is now up and running at its nominal power level. It is then possible to perform all the controls and verification that one thinks are necessary before putting it into operation.

5.2.3 Connections of a system in double exciter configuration

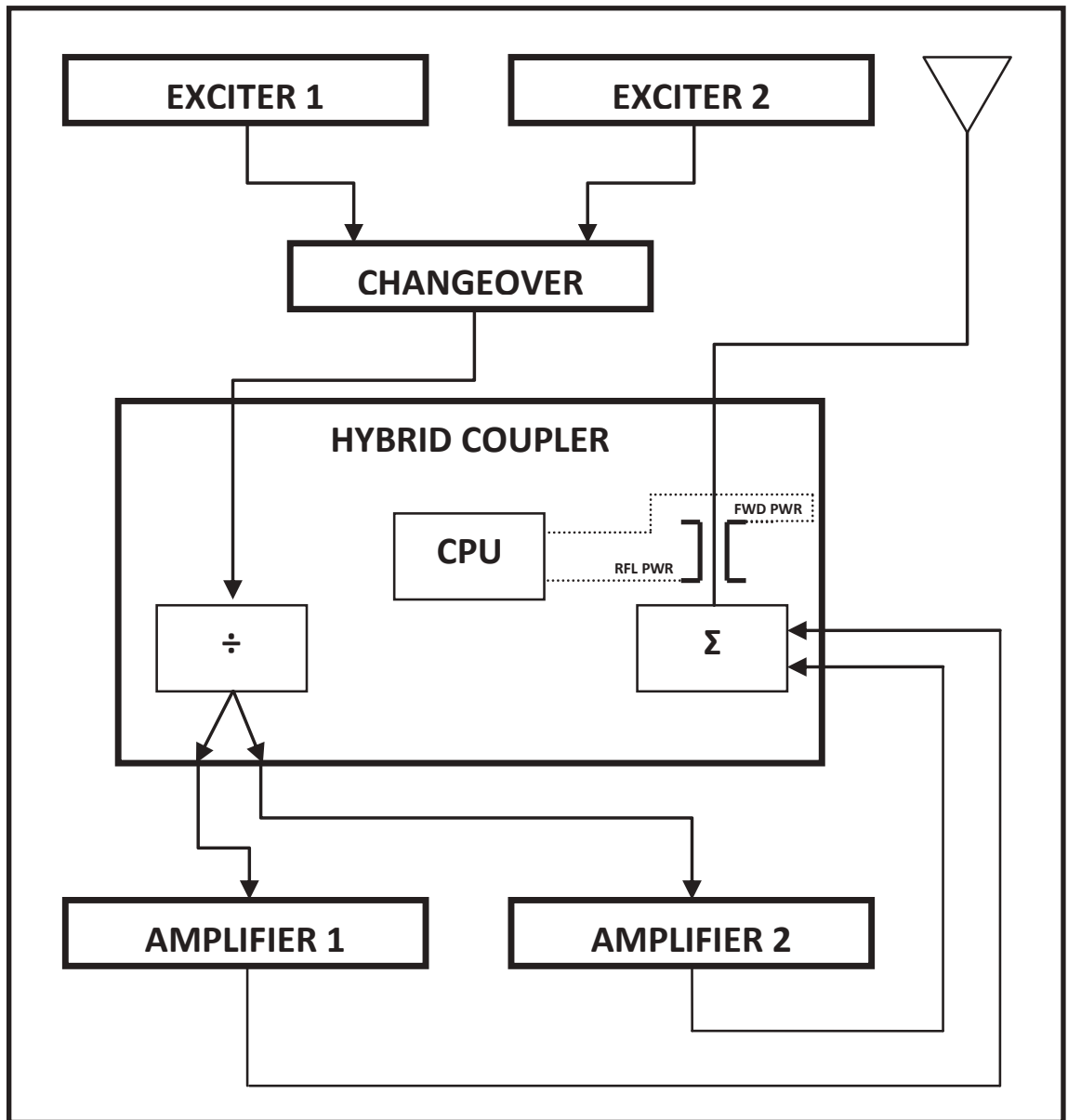

Double exciter configuration

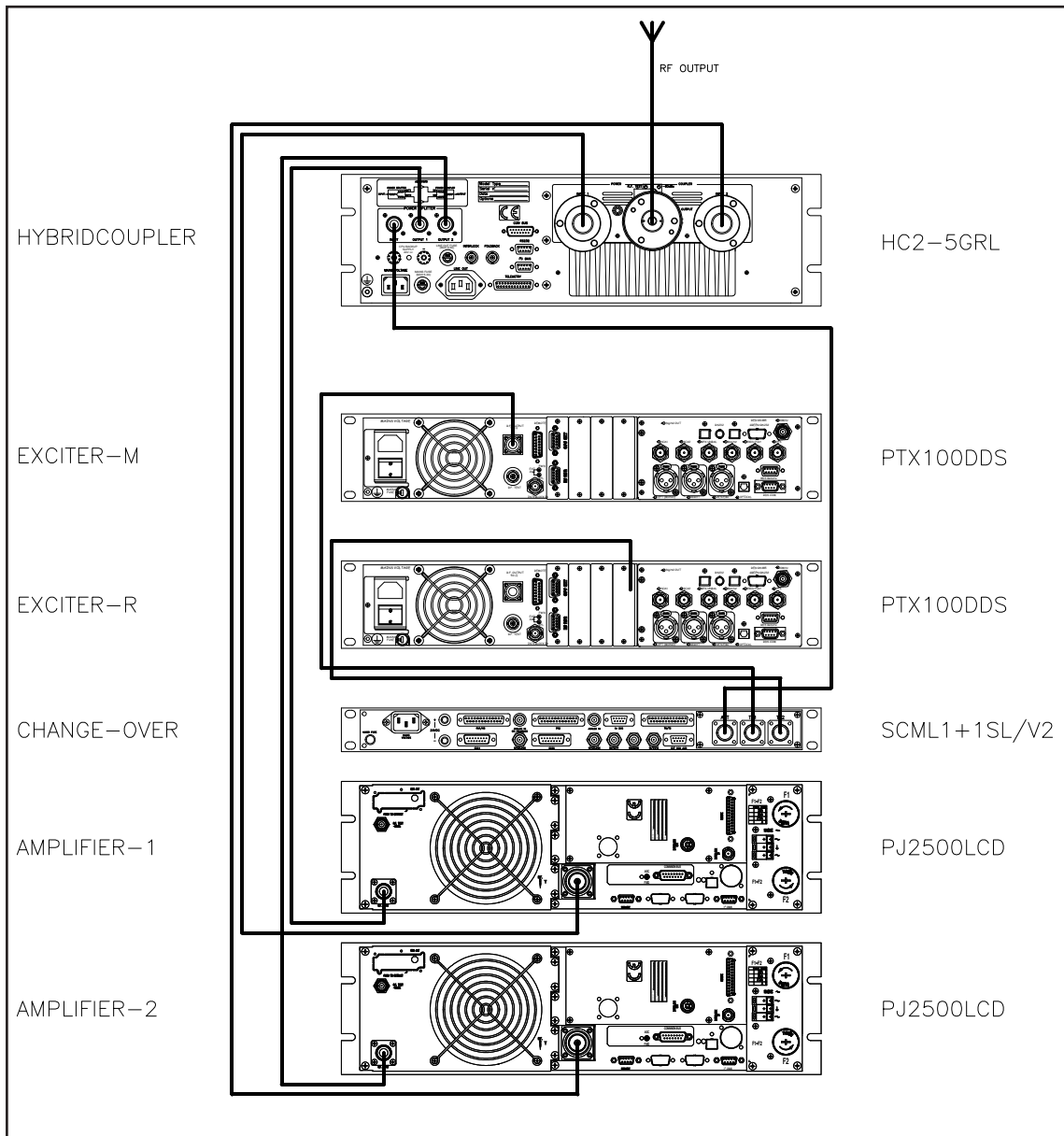

RF Connection

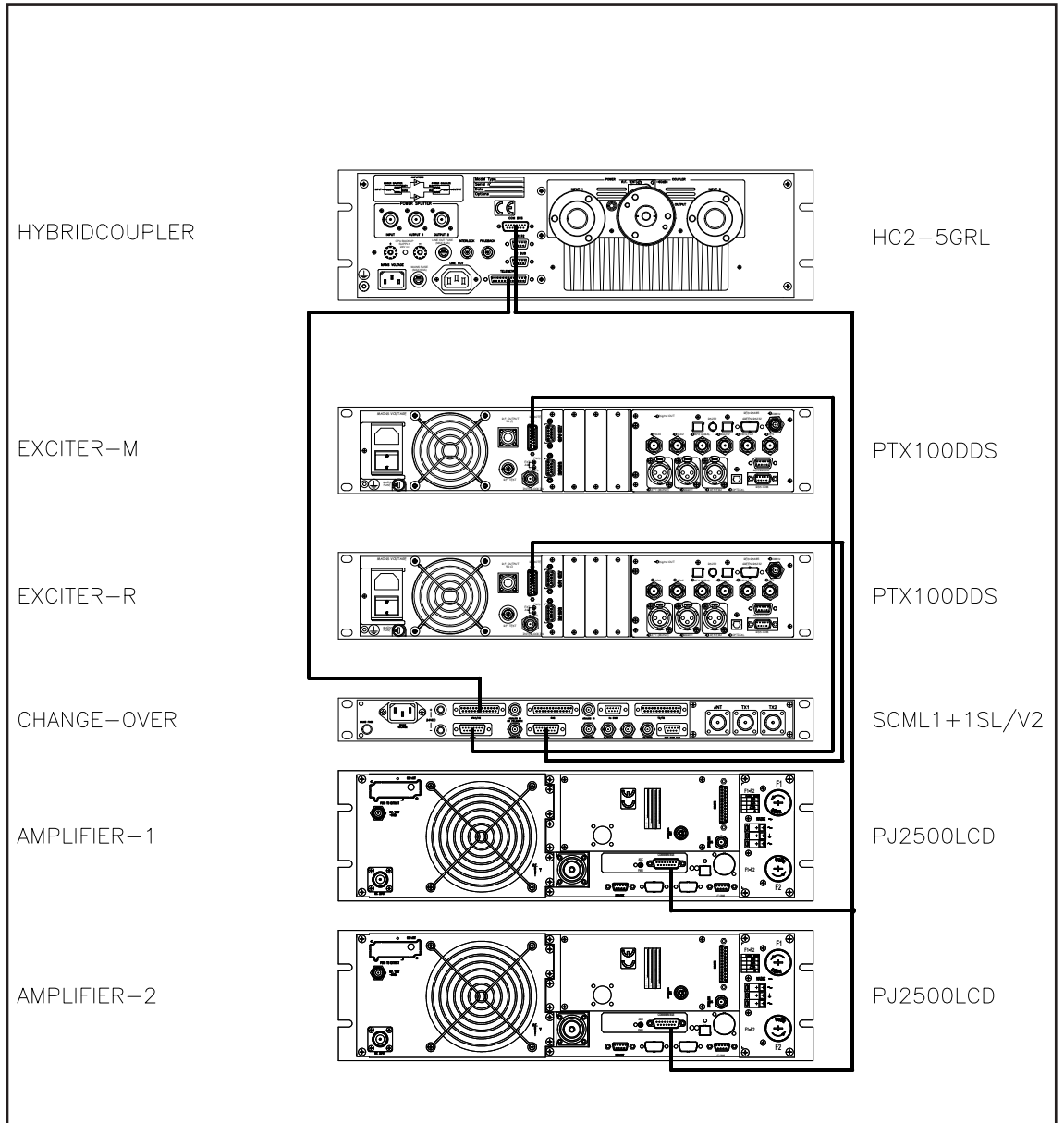

COMMAND Connection

5.2.4 Connections of a system in single exciter configuration

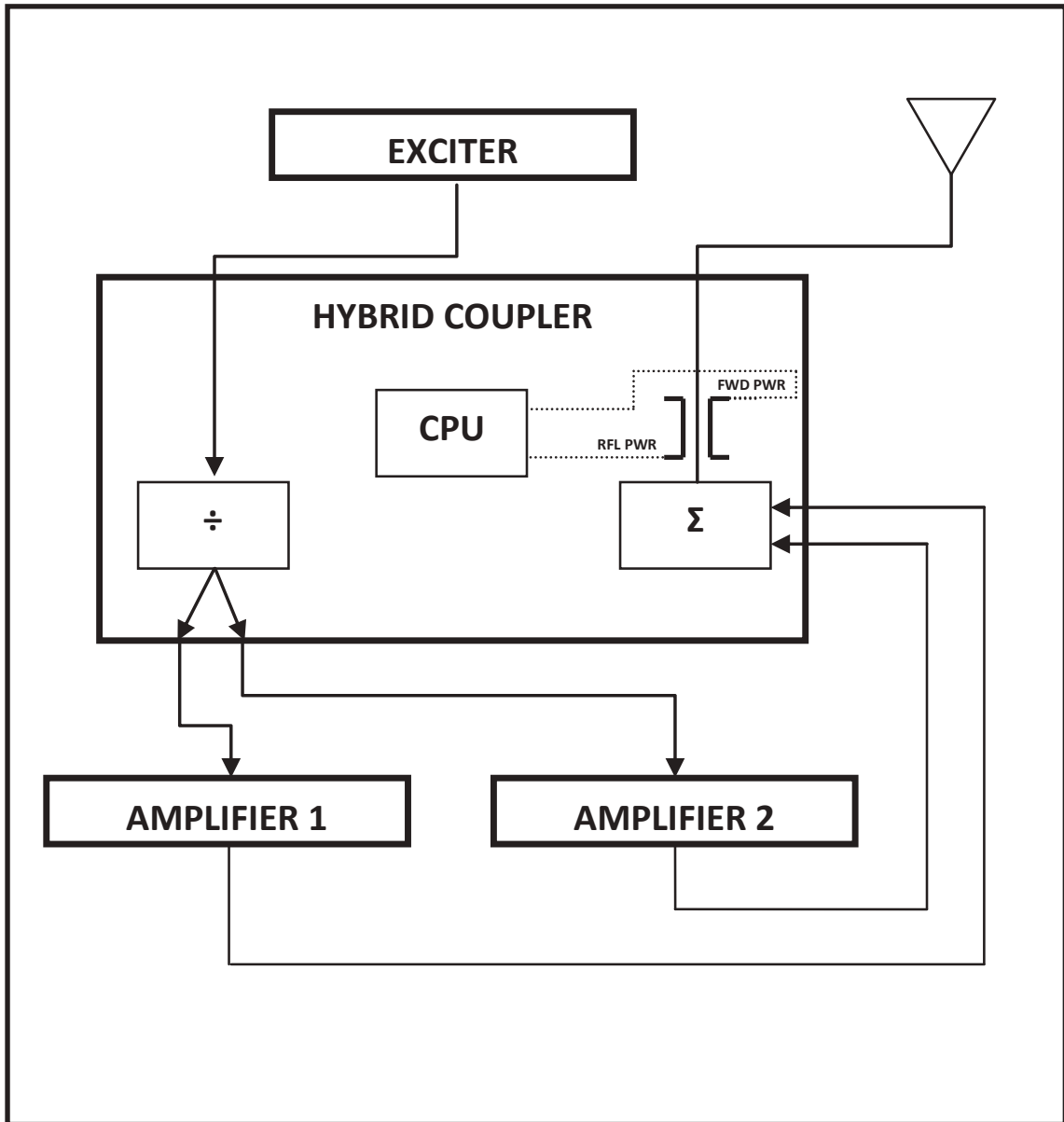

Single exciter configuration

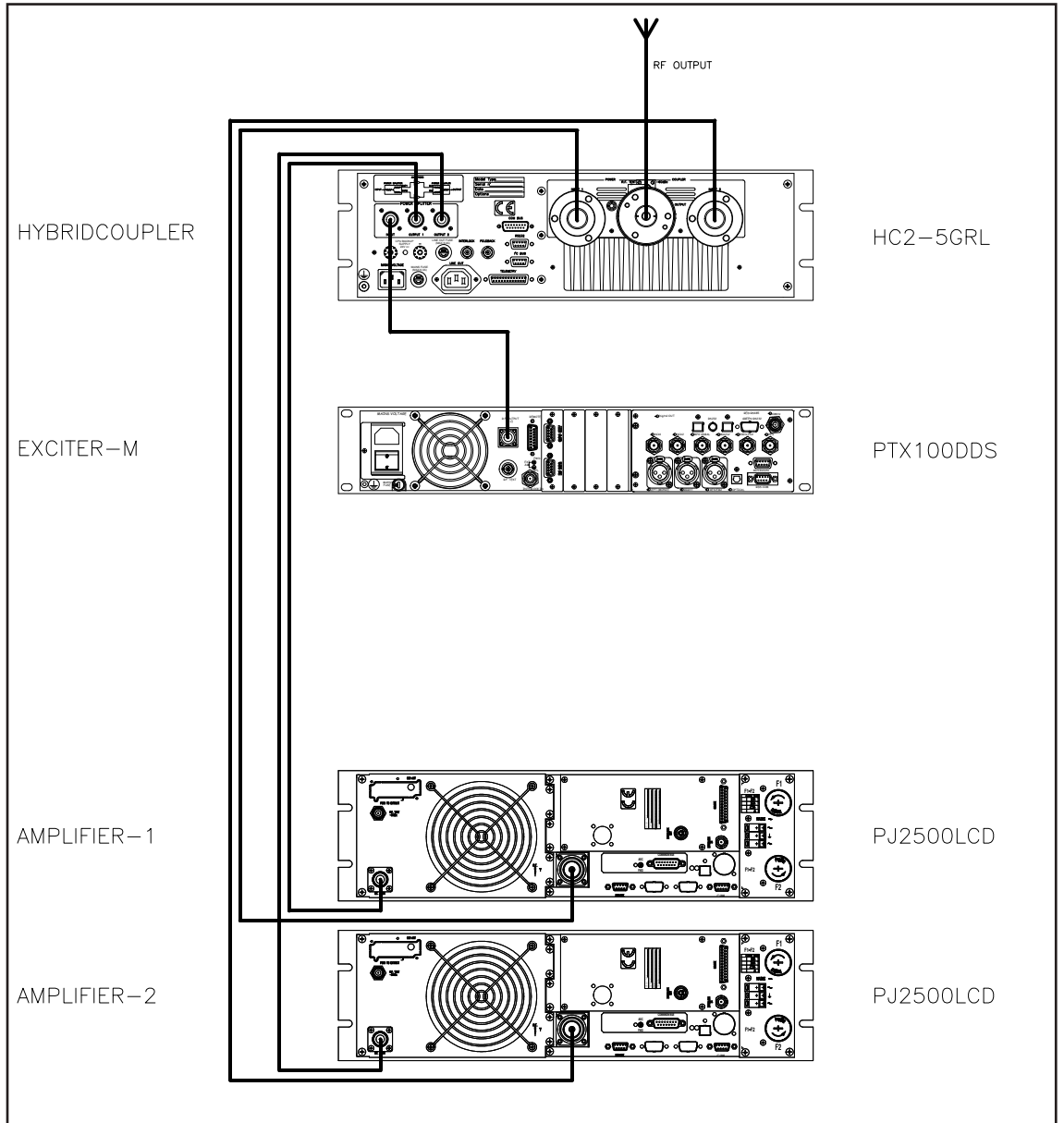

RF Connection

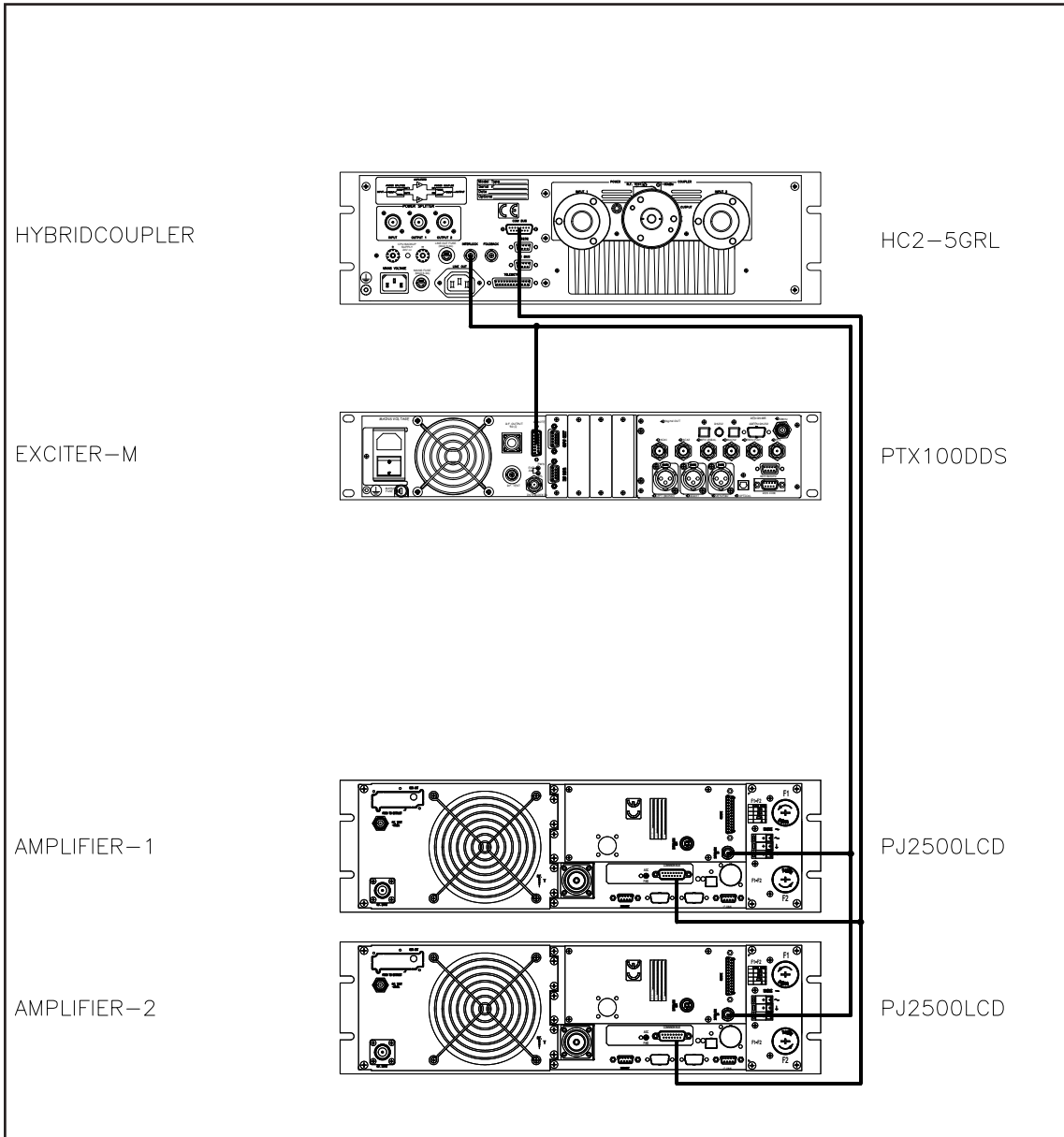

COMMAND Connection

6. Base Operations

6.1 Exciter (PTX DDS)

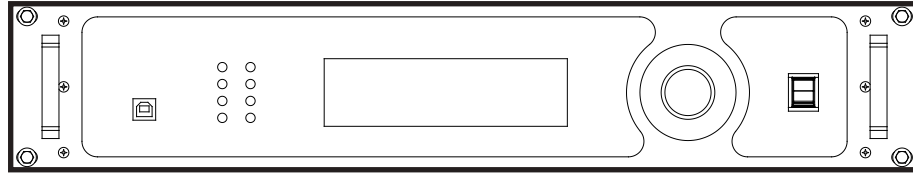

- Set the exciters following the instructions of the exciters that you are used to set the desired operating frequency. Adjust the output power of exciter to the power required to drive your transmitter.

Before that you enable the delivered power from exciter, it is suggested to check and, in case, correct the basic parameters under own necessity:

- frequency
- power
- audio input



Note: Some information here contained may be not necessary for the proper functioning of your transmitter.

- To enable/disable the power supply, please read the instructions in the manual of your exciter. It can be done typically in the first seconds of switching on of exciter (ie: for the PTX-DDS, after that a new window appearing accompanied by an intermittent beep, when you press the encoder the exciter's output power will disable). In this way, you can change the working parameters before you begin to transmit.



Note: turning the encoder, the cursor moves itself on indicators of the various sub-menus, while in the middle of the window it shows the contents. If you press the encoder while the indicator of a menu is highlighted on navigation bar, and if it contains adjustable parameters, the cursor moves within the central window of the display, allowing you to act on adjustable parameters. Every menu contains a "EXIT" field: by pressing the encoder while this field is highlighted, you will leave the submenu and return to navigation mode.

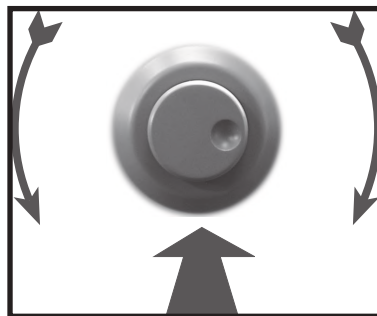

- To adjust the desired **working frequency** do the following operations: Select the Admin/**MAIN** (RFset) menu, rotate the encoder ● and then press it to enter in the submenu.

```

| |RF      :On      | |
| |Freq.  :000.000Mhz| |
| |F.Step:000      kHz| |
| |P.Out  :000      % | |
| |Rise t:000      Sec| |
| |FWD   : 0.0      W | |
| |RFL   : 0.0      W | |
| |Admin---[Exit]---| |

```

Select the **FREQ** field (working frequency), rotate the encoder ● and then press it to enter in modality of parameter modification.

Adjust the frequency by turning the encoder. Note that when you press the encoder to store the new frequency, the software requires confirmation about this value (“Are you sure?”). Highlighting the “Yes” field, and pressing the encoder, the choice will be confirmed.

- To adjust the desired **working power** do the following operations:

Select **Admin/MAIN** (RFset) menu, rotate the encoder ● and then press it to enter in the submenu.

```

| |RF      :On      | |
| |Freq.  :000.000Mhz| |
| |F.Step:000      kHz| |
| |P.Out  :000      % | |
| |Rise t:000      Sec| |
| |FWD   : 0.0      W | |
| |RFL   : 0.0      W | |
| |Admin---[Exit]---| |

```

Select the **FWD** field (reading and adjustment of delivered power), rotate the encoder ● and then press it to enter in modality of parameter modification.

The reading is expressed in Watt, while the adjusted value is expressed as a percentage of maximum power. Pressing the encoder ● when the cursor is on this option, the unit indicator of measurement changes from “W” to “%”, and turning the encoder ● you can set the percentage value. Pressing the encoder ● the new value is stored.

- To adjust the desired audio input do the following operations:

Select the **Admin/BdSet** (audio board adjustment), rotate the encoder ● and then press it to enter in submenu.

```

| |Input :Analog | |
| |Mode A:Mono | |
| |Mode D:Auto | |
| |Mode X:Stereo | |
| |Preemp: 50 uS | |
| |PilLev:+00.0 dB | |
| |PilPhs:+00.0 Deg| |
| |Admin--- [Exit] ---| |
  
```

Select the Input (audio input modality or the automatic rescuer activation. The status can be set Analog (analogic inputs), Digital (digital inputs), MPX (composite input) or Auto A-D-X (automatic input rescuer), rotate the encoder and then press it to enabled or disabled the audio input modality.

Select the Mode A, Mode D or Mode X (selection of the coder modality in analogic, digital or MPX operation), rotate the encoder and then press it to enabled or disabled the audio input.

	Mode A	Mode D	Mode X	Description
Stereo	x	x	x	Stereophonic mode
Stereo + RDS	x	x	x	Stereophonic with RDS mode
Mon L	x	x		Monophonic mode with only left channel enabled
Mon L +RDS	x	x		Monophonic with RDS mode and only left channel enabled
MonL+R	x	x		Monophonic mode with right & left channels enabled
MonL+R +RDS	x	x		Monophonic with RDS mode and right & left channels enabled
Mono			x	Monophonic mode
Mono +RDS			x	Monophonic with RDS mode
Auto		x		Automatic mode selection
Auto +RDS		x		Automatic mode selection with RDS
Stereo +SCA	x	x	x	Stereophonic mode and SCA enabled
Stereo +SCA +RDS	x	x	x	Stereophonic with RDS mode and SCA enabled
Mon L +SCA	x	x		Monophonic mode with SCA and only left channel enabled
Mon L +SCA +RDS	x	x		Monophonic with RDS mode, SCA and only left channel enabled
MonL+R +SCA	x	x		Monophonic mode with SCA and right & left channels enabled
MonL+R +SCA +RDS	x	x		Monophonic with RDS mode, SCA and right & left channels enabled
Mono +SCA			x	Monophonic mode and SCA enabled
Mono +SCA +RDS			x	Monophonic with RDS mode and SCA enabled
Auto +SCA		x		Automatic mode selection with SCA enabled
Auto +SCA +RDS		x		Automatic mode selection with RDS and SCA enabled



Note: when the exciter is set in STEREO mode, the level adjustment of the two channels are bound to be equal.

6.2 Amplifier (PJ LCD)

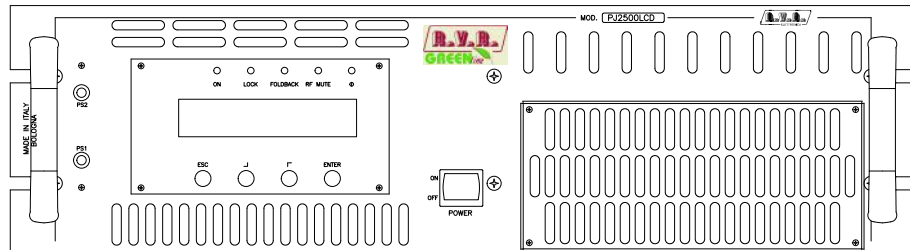

• Adjust the power of each amplifier through Power Setup menu, the overall RF output emitted by transmitter appears on the HC LCD display.

```

Fwd:    2.4    kW
Rf1:    12     W
  
```

6.3 Changeover (SCML1+1SL)

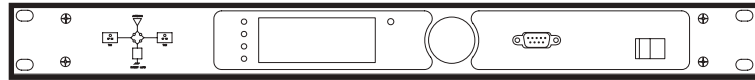

- Set the changeover between exciters following the instructions below.
Before that you enable the delivered power from main exciter, it is suggested to check and, in case, correct the basic parameters under own necessity:
 - local/remote status
 - changeover



Note: Some information here contained may be not necessary for the proper functioning of your transmitter.



R.V.R. Elettronica S.p.A.

Via del Fonditore, 2 / 2c
Zona Industriale Roveri · 40138 Bologna · Italy
Phone: +39 051 6010506 · Fax: +39 051 6011104
e-mail: info@rvr.it · web: <http://www.rvr.it>

ISO 9001:2000 certified since 2000



The RVR Logo, and others referenced RVR products and services are trademarks of RVR Elettronica S.p.A. in Italy, other countries or both. RVR ® 1998 all rights reserved.
All other trademarks, trade names or logos used are property of their respective owners.